



GSA prices effective April 2, 2018
(based on February 6, 2017, commercial price list)
Published June 2018

Storage Systems

Meridian® Lateral Files

General Services Administration Federal Supply Service Authorized Federal Supply Schedule Price List

Online access to contract ordering information, terms and conditions, up-to-date pricing, and the option to create an electronic delivery order is available through GSA Advantage!, a menu-driven database system. The Internet address for GSA Advantage! is www.gsaadvantage.gov.

Office Furniture
FSC Group 71, Part 1
Contract Number: GS-03F-036DA
Contract Period: December 21, 2015—December 20, 2020

Herman Miller, Inc.
855 East Main Avenue
Zeeland, Michigan 49464
(616) 654 3000 Phone
(616) 654 8278 Fax
www.HermanMiller.com/government

Business Size: Large

Contract Information

1a. Special Item Numbers (SIN)

SIN 71-1
Packaged Offices

SIN 711-1
Furniture Systems

SIN 711-2
Computer Furniture

SIN 711-3
Filing and Storage Cabinets

SIN 711-11
Tables and Accessories

SIN 711-16
Upholstered Seating

SIN 711-18
Multi-Purpose Seating

SIN 711-91
Project Management

Services under this SIN may be used only in conjunction with the purchase of new furniture. Please contact your local Herman Miller representative to discuss the available labor categories (listed below). The hourly rates listed are "Not To Exceed" or "NTE" values.

Furniture Project Manager: \$64.75 per hour
Furniture Project Coordinator: \$49.00 per hour
Build-Out Project Manager: \$80.00 per hour

SIN 711-93
Reconfiguration and Relocation Services

Reconfiguration and Relocation Services will be provided by Herman Miller, Inc., or its participating dealer based on a fee not to exceed \$55 per hour, which applies to services totaling \$150,000 (per SIN) and below only. Services above \$150,000 shall be negotiated on a case-by-case basis. This SIN may only be used with the purchase of new product under SIN 711-1.

See * Additional Notes for Installation & Reconfiguration and Relocation Services.

SIN 711-94
Design/Layout

Design service will be provided by Herman Miller, Inc., or its participating dealer based on a fee not to exceed \$65 per hour.

SIN 711-95

Installation Services

Installation Services will be provided by Herman Miller, Inc., or its participating dealer based on a fee not to exceed \$55 per hour (\$82.50 per hour for after-hours Installation), which applies to services totaling \$150,000 (per SIN) and below only. Services above \$150,000 shall be negotiated on a case-by-case basis.

See * Additional Notes for Installation & Reconfiguration and Relocation Services.

* Additional Notes for Installation & Reconfiguration and Relocation Services:

FOB Destination (Drop Ship): Price includes product delivery to the site, brought to the tailgate of the truck. The purchaser is responsible for unloading.

Prices effective up to the maximum order by SIN only. Above the MO, pricing shall be negotiated on a case-by-case basis between the client and local dealer.

Standard Services are Subject to the Following Conditions:

Installation will be performed during normal weekday working hours.

Adequate facilities for delivery, unloading, moving and staging/ storing the product during the installation process shall be provided.

Service work will not be hindered by other trades.

Electric, heat, and adequate elevator service will be furnished without charge.

The immediate installation area shall be complete and free of debris including the carpet/flooring before installation commences.

Any work requiring a licensed electrician is the responsibility of the buyer.

Additional Charges May Apply For:

Major Metro Markets and any non-ground floor installation.

Major Metro Markets include large population centers and urban environments.

Installation in a clinical/medical environment.

Special restrictions or limits established by local laws, ordinances or the directions of the buyer, including but not limited to restrictions on transportations of materials, street access to the job site and/or dock facilities.

Installations outside of a 50 mile radius of the servicing dealer.

Local Prevailing Wage and/or Union Labor Rates.

Any additional charges shall be quoted by the dealer and approved by the buyer prior to performance of the work.

SIN 711-96

Leasing

Contact Herman Miller participating government dealer for current leasing information.

SIN 711-99

New Product Introductions

Contract Information

continued

1b. Lowest Priced Model

SIN 711-1:	G9999.B	\$7
SIN 711-2:	6-5-D	\$35
SIN 711-3:	9M10018	\$14
SIN 711-11:	DT9A.	\$36
SIN 711-16:	OA401	\$41
SIN 711-18:	AS90598	\$46
SIN 711-99:	R1366	\$27

1c. Not applicable

2. Maximum Order

SIN 711-1, SIN 711-2
\$500,000 net product value

SIN 711-3, SIN 711-11
\$300,000 net product value

SIN 711-16, SIN 711-18
\$200,000 net product value

SIN 711-93
\$150,000

SIN 711-94
\$150,000

SIN 711-95
\$150,000

SIN 711-96
\$500,000 net product value

SIN 711-99
\$50,000 net product value

3. Minimum Order

\$100 net

4. Geographic Coverage

Continental U.S.

Orders for Alaska, Hawaii, and Puerto Rico will be shipped F.O.B. inland carrier point of exportation.

5. Point of Production

Zeeland, Ottawa County, Michigan
Spring Lake, Ottawa County, Michigan

6. Pricing

Prices shown are list. Discounts include Industrial Funding Fee.

SIN 711-1

Product: Selected Action Office 1, Action Office 2, C-Style Overhead Storage, Ethospace System, Quadrant Pedestals, Supplemental Products, Tu Pedestals and Pedastools, and approved Herman Miller Options Products.

Standard Lead Time	Single Order Net Purchase	Discount From list
	\$100 - 250,000	73.8%
	\$250,001 - 500,000	76.8%

SIN 711-1

Product: Selected Renew™ Tables, Renew Link and approved Herman Miller Options Products

Standard Lead Time	Single Order Net Purchase	Discount From List
	\$100 - 500,000	72.8%

SIN 711-1

Product: Selected Motia™ Tables, and approved Herman Miller Options Products

Standard Lead Time	Single Order Net Purchase	Discount From List
	\$100 - 500,000	73.8%

SIN 711-1

Product: Tu Wood Pedestals and approved Herman Miller Options Products

Standard Lead Time	Single Order Net Purchase	Discount From List
	\$100 - 300,000	74.3%

SIN 711-1

Product: Selected Canvas Office Landscape and approved Herman Miller Options Products

Standard Lead Time	Single Order Net Purchase	Discount From List
	\$100 - 500,000	74.8%

SIN 711-1

Product: Selected Layout Studio® and approved Herman Miller Options Products

Standard Lead Time	Single Order Net Purchase	Discount From List
	\$100 - 500,000	60.7%

SIN 711-1

Product: Selected Meridian Pedestals, Meridian Pedastools, and approved Herman Miller Options Products

Standard Lead Time	Single Order Net Purchase	Discount From List
	\$100 - 500,000	64.2%

Contract Information

continued

SIN 711-1

Product: Selected Thrive Portfolio and approved Herman Miller Options Products

Standard Lead Time	Single Order Net Purchase	Discount From List
	\$100 - 250,000	62%
	\$250,001 - 500,000	66.4%

SIN 711-2

Product: Passage Desking System and approved Herman Miller Options Products

Standard Lead Time	Single Order Net Purchase	Discount From List
	\$100 - 500,000	56.7%

SIN 711-2

Product: 5000 Series Furniture and approved Herman Miller Options Products

Standard Lead Time	Single Order Net Purchase	Discount From List
	\$100 - 500,000	58.7%

SIN 711-3

Product: Meridian Laterals, Verticals, Towers, and Storage products and approved Herman Miller Options Products

Standard Lead Time	Single Order Net Purchase	Discount From List Laterals	Verticals	Towers & Storage
	\$100 - 300,000	67.3%	66.3%	62.7%

SIN 711-3

Product: Tu Lateral Files, Tu Storage, Tu Towers, Tu Wood Cases, Tu Wood Cubbies, Tu Wood Credenzas, Tu Wood Towers, and approved Herman Miller Options Products

Standard Lead Time	Single Order Net Purchase	Discount From List
	\$100 - 300,000	74.3%

SIN 711-11

Product: Selected Tables and Accessories and approved Herman Miller Options Products

Standard Lead Time	Single Order Net Purchase	Discount From List
Avive® Tables	\$100 - 250,000	72.8%
	\$250,001 - 500,000	74.8%
Herman Miller Eames® Tables	\$100 - 250,000	73.6%
	\$250,001 - 300,000	77.6%
Everywhere™ Tables	\$100 - 300,000	72.8%

SIN 711-16

Product: Swoop upholstered seating products and approved Herman Miller Options Products

Standard Lead Time	Single Order Net Purchase	Discount From List
Swoop™	\$100 - 200,000	60.7%

SIN 711-18

Product: Selected Seating and approved Herman Miller Options Products

Standard Lead Time	Single Order Net Purchase	Discount From List
Aeron® (Classic and New)	\$100 - 200,000	64.5%
Aside®	\$100 - 200,000	64.2%
Caper®	\$100 - 200,000	61.5%
Celle®	\$100 - 200,000	59.7%
Embody®	\$100 - 200,000	59.7%
Equa 2®	\$100 - 200,000	65.8%
Ergon 3®	\$100 - 200,000	68.8%
Keyn	\$100 - 200,000	57.7%
Mirra® 2	\$100 - 200,000	61.7%
Setu®	\$100 - 200,000	59.7%
Sayl®	\$100 - 200,000	62.2%
Verus™	\$100 - 200,000	63.7%

SIN 711-99

Product: Selected Exclave™, Locale®, Public Office Landscape®, Resolve® System, and approved Herman Miller Options Products

Standard Lead Time	Single Order Net Purchase	Discount From List
Exclave	\$100 - 50,000	61.7%
Locale	\$100 - 50,000	63.7%
Public Office Landscape	\$100 - 50,000	61.7%
Resolve System	\$100 - 50,000	69.8%
Intent Solution	\$100 - 50,000	58.7%

7. Quantity Discounts

Reference item #6.

8. Payment Term

Net 30 days

9. Government Commercial Credit Card

- Government commercial credit cards are accepted below the micropurchase threshold.
- Government commercial credit cards are accepted above the micropurchase threshold.

10. Foreign Items

None

11. Time of Delivery

- 90 day ARO
- Expedited delivery: Items listed in the 10-Day section of the catalogs are available for expedited delivery.
- Overnight/2-day delivery: Select items may be available for overnight or 2-day delivery. Contact Herman Miller or a participating dealer for availability and rates.
- Urgent requirements: Agencies may contact contractor or participating dealer to request faster delivery.

Contract Information

continued

12. F.O.B.

F.O.B. destination except Alaska, Hawaii, and Puerto Rico, which will be shipped F.O.B. inland carrier point of exportation.

13. Ordering Address

- a. Herman Miller, Inc.,
Government Customer Care 0161
855 East Main Avenue
Zeeland MI 49464.
- b. For supplies and services, the ordering procedures information on Blanket Purchase Agreements (BPA's) and a sample BPA can be found at the GSA/FSS Schedule homepage (www.fss.gsa.gov/schedules).

14. Payment Address.

Herman Miller, Inc.
22764 Network Place
Chicago, IL 60673-1227

15. Warranty

Herman Miller, Inc., commercial warranty applies.

16. Export Packing Charge

Prices supplied on request.

17. Terms and Conditions of Government Purchase Card Acceptance

(any thresholds above the micropurchase level)
None.

18. Rental Maintenance and Repair Terms

Not applicable

19. Terms and Conditions of Installation

Installation Services will be provided by Herman Miller, Inc., or its participating dealer based on a fee not to exceed \$55 per hour (\$82.50 per hour for after-hours Installation), which applies to services totaling \$150,000 (per SIN) and below only. Services above \$150,000 shall be negotiated on a case-by-case basis.

Additional Notes for Installation & Reconfiguration and Relocation Services:

FOB Destination (Drop Ship): Price includes product delivery to the site, brought to the tailgate of the truck. The purchaser is responsible for unloading.

Prices effective up to the maximum order by SIN only. Above the MO, pricing shall be negotiated on a case-by-case basis between the client and local dealer.

Standard Services are Subject to the Following Conditions:

Installation will be performed during normal weekday working hours.

Adequate facilities for delivery, unloading, moving and staging/storing the product during the installation process shall be provided.

Service work will not be hindered by other trades.

Electric, heat, and adequate elevator service will be furnished without charge.

The immediate installation area shall be complete and free of debris including the carpet/flooring before installation commences.

Any work requiring a licensed electrician is the responsibility of the buyer.

Additional Charges May Apply For:

Major Metro Markets and any non-ground floor installation.

Major Metro Markets include large population centers and urban environments.

Installation in a clinical/medical environment.

Special restrictions or limits established by local laws, ordinances or the directions of the buyer, including but not limited to restrictions on transportations of materials, street access to the job site and/or dock facilities.

Installations outside of a 50 mile radius of the servicing dealer.

Local Prevailing Wage and/or Union Labor Rates.

Any additional charges shall be quoted by the dealer and approved by the buyer prior to performance of the work.

20. Terms and Conditions of Repair Parts

Not applicable

21. Service and Distribution Points

For service and distribution points nearest you, call (800) 851 1196.

22. Participating Dealers

Access Herman Miller web site for current list of participating dealers: www.HermanMiller.com/government.

23. Preventive Maintenance

Not applicable

24a. Special Attributes.

2018

For the 11th consecutive year, Herman Miller received a perfect score on the Corporate Equality Index and we were designated as Best Place to Work for LGBT equality. This report evaluates U.S. companies in terms of diversity, particularly their LGBT-related policies and practices.

Contract Information

continued

2017

Herman Miller was named the 2017 “Corporation of the Year” in the consumer products sector by the Michigan Minority Supplier Development Council (MMSDC).

Herman Miller has received a 2017 SEAL (Sustainability, Environmental Achievement and Leadership) Business Sustainability Award.

Herman Miller has earned the 4 Star Diversity Visionary Award. This award celebrates the diversity, equality, and inclusion work of Herman Miller. The award is presented at the annual Diversity Equity Inclusion Summit, held by the Grand Rapids Area Chamber of Commerce.

Herman Miller named one of the Best and Brightest in Wellness for the fifth year in a row.

Working Mother magazine has recognized Herman Miller as one of the 2017 Working Mother 100 Best Companies.

Herman Miller earned our tenth consecutive perfect score in Human Rights Campaign (HRC) Foundation’s 2017 Corporate Equality Index.

As one of the top-scoring companies in our industry for the thirteenth consecutive year, Herman Miller has qualified for inclusion in RobecoSAM’s 2017 Sustainability Yearbook and received the Bronze Class distinction for our excellent economic, environmental, and social sustainability performance.

Herman Miller has once again earned the WorldatWork Seal of Distinction, a unique standard of excellence in work-life effectiveness that shows we provide a distinct, mutually beneficial workplace experience.

2016

Herman Miller was recognized as the Business of the Year at the Annual Meeting of the West Michigan Environmental Action Council (WMEAC). This award goes to the business with the greatest depth and breadth of support, unwavering dedication to environmental action in West Michigan, and a strong corporate commitment to environmental advocacy.

The 101 Best and Brightest Sustainable Companies once again (fifth consecutive year) recognized Herman Miller as an organization in Michigan (and for the first time, in the nation) that exhibits leadership and innovation in its approach to sustainability.

Herman Miller has been recognized by the Michigan Minority Supplier Development Council (MMSDC), as a “Corporation of the Year”, and we also received a “2016 Excellence in Supplier Diversity Award” from the Great Lakes Women’s Business Council. Additionally, we are the only West Michigan company this year to receive an “Ambassadors Championing Excellence” Award from the MMSDC.

Plex Lounge Furniture from Herman Miller receives #MetropolisLikes award at NeoCon 2016.

Plex Lounge Furniture from Herman Miller receives Interior Design HiP Award for Workplace Seating/Lounge at NeoCon 2016.

Spot Stools from Herman Miller Collection receive Interior Design HiP Award for Hospitality Seating at NeoCon 2016.

Herman Miller has been named a 2020 Women on Boards Winning Company. Companies selected for this recognition are considered champions of board diversity as 20 percent or more of their board seats are occupied by women.

Herman Miller selected for inclusion in the 2016 RobecoSAM Sustainability Yearbook for twelfth consecutive year.

Herman Miller again earns the WorldatWork Work-Life 2016 Seal of Distinction. This award identifies organizations that focus on programs that promote work-life balance and overall well-being.

2015

Herman Miller earns ninth consecutive perfect score in Human Rights Campaign (HRC) Foundation’s 2016 Corporate Equality Index and we were designated as Best Place to Work for LGBT equality.

This is the fourth consecutive year that Herman Miller was named one of Michigan’s Best and Brightest Sustainable Companies.

Herman Miller has received the Best and Brightest in Wellness Award for the third year in a row. This program is an innovative initiative that recognizes and celebrates quality and excellence in health awareness.

Herman Miller received the Forest Stewardship Council (FSC) Leadership Award for longstanding commitment to manufacturing with wood sourced from responsibly managed forests, which reduces environmental impacts by protecting against deforestation and forest degradation.

Herman Miller accepted its second Excellence in Reusable Packaging Award from the Reusable Packaging Association.

Herman Miller has once again been recognized for its commitment to best-in-class economic, environmental, and societal sustainability, earning a spot on the prestigious Dow Jones Sustainability Index (DJSI) for the twelfth consecutive year. We are the only contract furniture company recognized globally for its corporate sustainability leadership.

Herman Miller selected for inclusion in the 2015 RobecoSAM Sustainability Yearbook; awarded Bronze Class distinction for excellent sustainability performance for the second consecutive year.

Contract Information

continued

Herman Miller received a Michigan Business Pollution Prevention (MBP₃) Certificate – a recognition given by the Michigan Department of Environmental Quality (MDEQ) to organizations committed to environmental stewardship, conservation, and sustainable operations. This basic partnership with the MDEQ, which we've maintained since 1998, makes us eligible for our Clean Corporate Citizen (CCC) status that began in 2004 and our Environmental Leader status, which we received for the first time this past year.

MedAssets named Herman Miller Healthcare as Platinum Suppliers. MedAssets, a large group purchasing organization, helps providers enhance operational and financial performance so they can sustainably serve the needs of their community.

Herman Miller honored with five of 20 spots for the Michigan Environmental Leaders Award by the Michigan Department of Environmental Quality for our outstanding, voluntary environmental stewardship.

Renew Sit-to-Stand tables recognized on Record Products 2014 list by Architectural Record.

Herman Miller was again awarded a perfect score in the 2015 Corporate Equality Index. This is the eighth consecutive year we received a perfect score.

2014

Herman Miller has received the Best and Brightest in Wellness Award for the second year in a row. This program is an innovative initiative that recognizes and celebrates quality and excellence in health awareness.

Herman Miller's Locale wins International Design Excellence Awards (IDEA) Gold in the Office & Productivity category.

Herman Miller achieves eleventh consecutive listing on Dow Jones Sustainability World Index, an international stock portfolio that evaluates the annual performance of the world's largest 2500 companies using economic, environmental, and social criteria, known as the "triple bottom line" of sustainability.

2013

Herman Miller achieves tenth consecutive listing on Dow Jones Sustainability World Index.

Herman Miller has received the Best and Brightest in Wellness Award. This program is an innovative initiative that recognizes and celebrates quality and excellence in health awareness.

Herman Miller Earns Perfect Score on the Corporate Equality Index. We are one of only 303 major U.S. businesses to receive a perfect score in 2013, an achievement we have now obtained seven years in a row.

Herman Miller is listed in Forbes Magazine inaugural "Platinum List" of America's 400 best managed, large companies.

For the second consecutive year, Herman Miller is honored as one of West Michigan's "101 Best and Brightest Sustainable Companies".

2012

Herman Miller accepted its first Excellence in Reusable Packaging Award from the Reusable Packaging Association.

Herman Miller is named "Corporation of the Year" in the commercial products sector by the Michigan Minority Supplier Development Council.

In July 2012 Herman Miller was inducted into the Made in the USA Hall of Fame. Herman Miller is one of only 20 companies across the nation to receive this distinction.

Herman Miller achieves ninth consecutive listing on Dow Jones Sustainability World Index.

Herman Miller is honored as one of West Michigan's 101 Best and Brightest Sustainable Companies.

The Sustainable Asset Management (SAM) group selected Herman Miller for inclusion in "The Sustainability Yearbook 2012" and has awarded Herman Miller both the "SAM Sector Leader" and "SAM Sector Mover" distinctions.

Herman Miller was named one of 16 Section Leaders on Climate Counts 2011-2012 Scorecard Report, making us the industry leader for Home and office Furnishings.

SGS International Certification Services, Inc., recognizes Herman Miller's manufacturing sites, Midwest Distribution Center, and Design Yard for initial certification to the OHSAS 18001 standard as well as re-certification to ISO 14001.

2011

Trust Across America, a company dedicated to unraveling the complexities of trustworthy business behavior, listed Herman Miller as one of their "Top Ten Most Trustworthy Companies in America 2011."

The U.S. Environmental Protection Agency (EPA) selected Herman Miller, as a WasteWise Gold Achievement—Climate Change winner.

Herman Miller achieves eighth consecutive listing on Dow Jones Sustainability World Index, an international stock portfolio that evaluates the annual performance of the world's largest 2500 companies using economic, environmental, and social criteria, known as the "triple bottom line" of sustainability.

The Michigan Minority Supplier Development Council (MMSDC) named Herman Miller as its "Corporation of the Year" in the commercial products sector. This was the fifth time Herman Miller has received this award since 2005.

Contract Information

continued

Herman Miller accepted its third Neighborhood Environmental Partners (NEP) award from the Michigan Department of Natural Resources and Environment.

Herman Miller receives the Reader's Choice award from TreeHugger's Best of Green: Design and Architecture category for the SAYL chair.

Herman Miller earns Citibank's Global Environmental Vendor of the Year award.

The SAYL chair from Herman Miller was dubbed the "Product Design of the Year" from the 2010 International Design Awards (IDA) jury.

Herman Miller Healthcare's Compass system was awarded a 2011 Medical Design Excellence Award (MDEA) for its research-based design and ability to be used in a variety of healing spaces, while simultaneously improving the overall delivery of healthcare.

The Sustainable Asset Management (SAM) Group selected Herman Miller for inclusion in the "Sustainability Yearbook 2011" and awarded us both the "SAM Sector Leader" and "SAM Sector Mover" distinctions.

Herman Miller has received the top rating for a fourth consecutive year in the Human Rights Campaign (HRC) Foundation's eighth annual Corporate Equality Index. The "Best Places to Work for LGBT Equality" distinction is awarded to businesses that scored 100% on the HRC Foundation's 2011 Corporate Equality Index.

Herman Miller again tops contract furniture industry in FORTUNE's "Most Admired" Companies survey. For the 23rd time in 25 years.

2010

The NASDAQ OMX CRD Global Sustainability Index (QCRD) has included Herman Miller among their top 100 companies in the world.

Herman Miller achieves seventh consecutive listing on Dow Jones Sustainability World Index, an international stock portfolio that evaluates the annual performance of the world's largest 2500 companies using economic, environmental, and social criteria, known as the "triple bottom line" of sustainability. Herman Miller is one of approximately 300 companies worldwide and the only contract office furniture manufacturer, selected for this index.

Herman Miller has been recognized by Fast Company magazine as one of its 2010 Most Innovative Companies and among the more select Innovation All-Stars.

The U.S. Environmental Protection Agency's Office of Resource Conservation and Recovery has selected Herman Miller to receive the 2010 WasteWise Gold Achievement Award for Green Purchasing.

The Michigan Department of Natural Resources and Environment (MDNRE) has recognized Herman Miller's West Michigan manufacturing sites and Midwest Distribution Center as continuing Clean Corporate Citizens.

Herman Miller makes the U.S. Environmental Protection Agency's (EPA) list of the top fifty users of renewable electricity, of more than 1,200 organizations participating in the Green Power Partnership. This is the second consecutive time Herman Miller was recognized. Herman Miller was the only furniture manufacturer on the list.

Herman Miller accepted its second Neighborhood Environmental Partners (NEP) award from the Michigan Department of Natural Resources and Environment.

For the 22nd time in 24 years, Herman Miller was awarded the No. 1 industry ranking in a survey among the executives and board members of peer companies and independent industry analysts, as published in FORTUNE magazine's annual "Most Admired" companies feature.

The Michigan Department of Environmental Quality (MDEQ) recognizes Herman Miller's GreenHouse as one of Michigan's top environmental performers with a Clean Corporate Citizen (C3) longevity award. This recognizes that the GreenHouse has maintained its C3 designation for the past five years.

For the third year in a row, Herman Miller makes FORTUNE magazine's "100 Best Companies to Work For" list. Herman Miller is one of only three Michigan-based companies to make the list.

24b. Section 508 Compliance

Not applicable

25. Data Universal Numbering System (DUNS): 00-601-2801

26. Registered in System for Award Management (www.SAM.gov) Database

27. Cancellation

Prior to production, no cancellation charge will apply. After production, only actual cost incurred that the contractor can demonstrate if items are sold after 3 months.

28. Restocking Charges

Agencies must notify the contractor for authorization prior to returning any items. The customer agency will be required to pay all packaging and return freight charges. A restocking fee of 50% for Systems Furniture and 35% for all other product lines will be charged for any returned items.

Herman Miller Miscellaneous Information:

Federal ID Number: 38-0837640

Commercial and Government Entity Code (CAGE): 40636

Data Universal Numbering System (DUNS) 00-601-2801

Commercial Entity Code (CEC): 00702290J

Introduction	page 2
Meridian® Lateral Files	3
Stackable™ Lateral Files (Spec-A-File)	5
Freestanding Stackable Lateral Files (Standard Configuration)	25
Standard Pull	25
Arc Pull	30
Bar Pull	36
Bevel Pull	42
Ellipse Pull	47
Sloped Pull	52
Stackable Lateral File Tops	57
Mobile Stackable Lateral Files	59
Standard Pull	59
Bevel Pull	64
File Tops	69
File Surrounds	72
Stackable Lateral File Accessories	74
Indices	81
By Name	81
By Number	83
Appendices	
20-Day or Less/Assigned Lead-Time Order Information	
Keyed-Alike Information	
Vary Easy Program	
Customer's Own Material/Customer's Own Leather Order Information-Cushion Tops	
Proprietary Textiles Application Chart-Seating	
Proprietary Textile Colors-Seating	
Maharam® Application Chart-Seating	
Maharam Colors-Seating	
For the latest materials information, refer to the Materials pages on HermanMiller.com.	

Introduction

A Note on the Organization of This Book

There are a few signals that will help you understand the organization of this book. Once you know them, you should be able to find your way around easily.

Like a newspaper, this book is formatted with columns of text and illustrations that run vertically.

Information wraps from one column to the next and continues for as many pages as it needs to.

Black bars are clues.

A black bar at the top of a page signals the start of information about a product.

This information is divided into two sections, each signaled by a black bar. Product Information includes a description, additional notes, and dimensional drawings. Specification Information, which always begins at the top of a column, includes a series of steps. Each step represents a decision you need to make in order to complete your product number. Steps must be followed sequentially. The number of pages needed to complete information on a product varies; some will be complete in one page; others may fill three or four pages. Just continue going through the steps until you run into the next product, signaled by the black bar at the top of the page.

Black tabs running along the outside edge of the page help you locate what section you are in or what section you want to go to. You can thumb forwards or backwards to find a section; tabs and text appear on both sides of the page.

The additional pages in the back of the book include the appendices and indices. They are signaled by a long black bar running along the outside edge of the page.

The index is presented two ways.

The first index is in alphabetical order by product name. It can be helpful if you are new to the products and numbering scheme or if you are looking for a type of product, such as work chair or round table.

The second index is by product number. It lists, in alphanumeric order, the base product number, typically a five-digit number.

General Information

This book is effective April 2, 2018, subject to change without notice. Products may be purchased from authorized Herman Miller dealers who will quote prices upon request. For more information about our products and services or to see a list of dealers, visit www.HermanMiller.com.

All prices are list prices. Additional services, such as planning services, design, storage, and installation, are not included and must be added to these prices when the additional services are requested.

Illustrations, specifications, and prices are based on the latest information at the time of publication. The right is reserved to make changes at any time without notice in prices, fabrics, finishes, materials, specifications, and models, and also to discontinue models and finishes.

Dimensions shown in the drawings are engineering drawing dimensions rounded up to the nearest $\frac{1}{8}$ ". Product is shipped set up or knocked down. Products that include "Shipped knocked down" in the description require some assembly. If this statement does not appear in the description, the product is shipped assembled.

Service problems are normally handled by a Herman Miller authorized dealer. Where this cannot be accomplished on a local level, service problems should be referred to the Customer Care Representative for your region, Herman Miller, Inc., Zeeland, Michigan 49464.

20-Day or Less/Assigned Lead-Time Shipments

All products and options in this price book not designated by an Assigned Program icon  will ship in **20 business days or less** after being acknowledged by Herman Miller.

Products and options designated by an  are on the assigned lead-time program and may ship in 20 days, less than 20 days, or more than 20 days from order acknowledgement.

Stackable™ Lateral Files (Spec-A-File)

Meridian® Stackable™ Lateral Files

Drawer Capacity & 20" Depth Filing

Drawer Capacity	Module Type	Case Depth	30" Letter	30" Legal	36" Letter	36" Legal	42" Letter	42" Legal
	Side-to-Side Filing in: C,D,N,E,G,H,L & P modules	20" or 18"	26 1/2"	26 1/2"	32 1/2"	32 1/2"	38 1/2"	38 1/2"
	Front-to-Back Filing in: N, P, E & D modules	20" 18"	35 1/2" 31 1/2"	N/A N/A	41 1/2" 37 1/2"	35 1/2" 31 1/2"	53 1/4" 47 1/4"	35 1/2" 31 1/2"

Filing Comparison

42" Wide Drawers

Side-to-Side Letter or Legal
38 1/2 Filing Inches

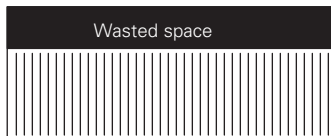

Front-to-Back Letter
53 1/4 Filing Inches



Note: 38% more filing capacity than side-to-side filing.

36" Wide Drawers

Side-to-Side Letter or Legal
32 1/2 Filing Inches

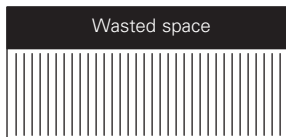

Front-to-Back Letter
41 1/2 Filing Inches



Note: 28% more filing capacity than side-to-side letter type.

Front-to-Back Legal
35 1/2 Filing Inches



Note: 9% more filing capacity than side-to-side legal type.

30" Wide Drawers

Side-to-Side Letter or Legal
26 1/2 Filing Inches

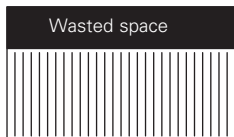

Front-to-Back Letter
35 1/2 Filing Inches

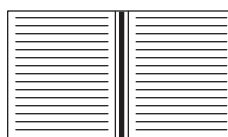

Note: 34% more filing capacity than side-to-side letter type.

Meridian® Stackable™ Lateral Files

General Information

Standard Pull (26)
Bar Pull (2KP)
Bevel Pull (24)

Spec-A-File

General Information

General Information

The Spec-A-File ordering procedure was designed to aid specifiers in meeting their exact filing needs. Since each component of the file (top, module, interior, base) is chosen individually, each file is a unique storage solution. The variety of top, module, and base heights available make the concern of meeting critical vertical heights a thing of the past.

Note: Metallic paints have an upcharge of \$65 when specified for the case, and \$10 when specified for the leg base.

Spec-A-File is comprised of the following four components. Each component must be clearly specified and priced separately.



Tops

Four heights are available ($\frac{1}{32}$ " , 1" , $1\frac{1}{4}$ " , $6\frac{1}{2}$ ") in finishes of baked enamel. Laminate and veneer tops are available in $1\frac{1}{4}$ " only. Veneer tops with oversail edge are $1\frac{1}{8}$ " .

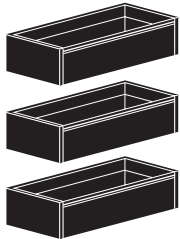

Modules

Various modules are available in heights of $11\frac{3}{4}$ " , $13\frac{1}{8}$ " , $15\frac{1}{8}$ " , $17\frac{5}{8}$ " and $26\frac{1}{4}$ " .

Interiors

Several interior options are provided to meet your filing needs.



Bases

Five heights are available (1" , $1\frac{1}{2}$ " , $2\frac{1}{4}$ " , $3\frac{1}{4}$ " , $4\frac{1}{4}$ ") in finishes of baked enamel.

Locks

Flush locks.



Final Assembly

Meridian will assemble all components as a complete lateral file up to 78" . Files taller than 78" will be shipped as two units for final field assembly. Instructions are included.

Meridian® Stackable™ Lateral Files

Advanced Options

Spec-A-File



Add-On Modules

In order to accommodate additional filing needs, add-on modules are available for field installation to an existing lateral file. Modules do not have a base and can be ordered with or without a top. If a lock cylinder is needed, see lock appendix for ordering information. If the lock cylinder resides in the existing file, the add-on modules will need to be specified with lockbars.

Example: 26-3618-ADDON

Lock Option: LB-Lockbars, to attach to an existing unit



Reversed Modules

Reversed file drawers allow one stack of lateral file modules to service two users—conserving floor space. For safety reasons, only one direction reversal is allowed per file. The number of modules facing each direction is not limited.

Drawers are reversed in the field by utilizing a stile lock hardware kit for additional lock and a reversing conversion kit for additional inter-lock pieces. Kit number: U1B31V4

Factory-reversed units need to be ordered through Herman Miller Options.

Advanced Options

The flexibility and modularity of the stackable lateral file modules allow a specifier to create an infinite number of storage solutions.

To further enhance the uniqueness of the file, use one of the following advanced options available in Advanced Spec-A-File:

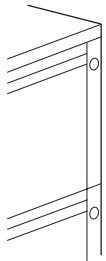

Multiple Locks – Standard Pull

Since the lock is housed in the module frame of standard pull lateral files, locks can be strategically placed to accommodate multiple users in one filing unit. In the case of keyed alike, identified modules will have factory-installed lockbars and lock hole knocked out to allow for field installation of lock cylinder. If additional security is required between drawers, specify security pans between modules.

Existing files can be retrofitted with multiple locks by requesting a stile lock hardware kit from your Customer Care representative.

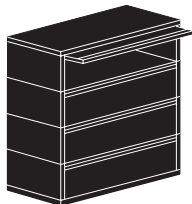

Combination Lateral File

It is considered to be a combination lateral file when combining standard pull with bevel or contour pull lateral file drawers. To specify a combination unit, choose a bevel or contour pull lateral file in Advanced Spec-A-File. The standard pull modules will be listed on the module choices, signified by the following note (2600 Series).

Multiple Paints

Multiple paints are available on a single unit by specifying one of the following options:

F: Different case and front finishes
M: Different top, module, and base finishes
N: Unit all one color







Meridian® Stackable™ Lateral File Tops

Standard Pull (26)

Bar Pull (2KP)

Bevel Pull (24)

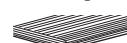
Spec-A-File

Tops	Description	Spec Code	H	D	W	LIST PRICE
No Top		NT				N/C
 Square Edge Metal Top	Metal top with square edge. Baked enamel finish.	T1	1"	20" or 18"	30"	\$ 63.
					36"	\$ 79.
					42"	\$ 94.
		T2	1 1/4"	20" or 18"	30"	\$ 63.
					36"	\$ 79.
					42"	\$ 94.
 Radius Edge Metal Top	Metal top with radius edge front and back. Baked enamel finish.	T3	1 1/4"	20" or 18"	30"	\$ 126.
					36"	\$ 141.
					42"	\$ 157.
 Laminate Top with Vinyl Edge*	Laminate top with vinyl edge.	TL	1 1/4"	20" or 18"	30"	\$ 135.
					36"	\$ 150.
					42"	\$ 166.
 Wood Veneer Top	Wood veneer top with 3mm edge banding.	TF A	1 1/4"	20" or 18"	30"	\$ 218.
					36"	\$ 234.
					42"	\$ 251.
 Recut Veneer Top	Recut veneer top with 3mm edge banding.	TR A	1 1/4"	20" or 18"	30"	\$ 212.
					36"	\$ 228.
					42"	\$ 245.
 Wood Veneer Top with Oversail Front Edge*	Wood veneer top and wood composite edge with oversail front.	TV1 A	1 1/8"	20" or 18"	30"	\$ 385.
					36"	\$ 400.
					42"	\$ 417.
 Security Top	Flat steel cover with baked enamel finish. Designed to protect contents and minimize overall height; not to be used for support or as an exposed top. Available on N, E and H modules and Overhead Storage Units only.	T6	1/32"	20" or 18"	30"	\$ 63.
					36"	\$ 79.
					42"	\$ 94.
 Planter Top*	Steel shell with baked enamel finish. Includes black plastic tub liner. Cannot house a lock.	T7	6 1/2"	20" or 18"	30"	\$ 264.
					36"	\$ 278.
					42"	\$ 298.
<p>* Note: When ordering a radius edge laminate top, laminate top with vinyl edge banding, planter top with a contour pull or bevel pull product, or a veneer top with oversail edge, an additional top is required if the file is to include a lock. Call Customer Service for details.</p>						



Meridian® Stackable™ Lateral File Dome Tops

Standard Pull (26)

Bar Pull (2KP)

Bevel Pull (24)

Spec-A-File

Tops	Description	Spec Code	H	D	W	LIST PRICE
	6 1/2" high metal top with full dome side-to-side. Baked enamel finish.	D1	6 1/2"	18" or 20"	30"	\$ 337.
					36"	\$ 353.
					42"	\$ 369.
	6 1/2" high metal top with half dome sloping left. Baked enamel finish.	H1	6 1/2"	18" or 20"	30"	\$ 337.
					36"	\$ 353.
					42"	\$ 369.
	6 1/2" high metal top with half dome sloping right. Baked enamel finish.	H2	6 1/2"	18" or 20"	30"	\$ 337.
					36"	\$ 353.
					42"	\$ 369.

Note: When specifying a half dome or full dome top with bevel, bar or contour pull lateral files, a lock option is not available.

Meridian® Stackable™ Lateral File Cushion Tops/Cushion Fabrics

Standard Pull (26)

Bar Pull (2KP)

Bevel Pull (24)

Spec-A-File

Tops	Description	Spec Code	H	D	W	LIST PRICE
	Cushion top available 1" or 2" high, provides temporary guest seating. Attaches with velcro strips to 1" metal top included.	TC1	1"	18" or 20"	30"	\$ 390.
		TC2	2"		36"	\$ 390.
					42"	\$ 391.

Tops	Description	Spec Code	Fabric Category	UPCHARGE
	Cushion available in Herman Miller seating fabric. Fabric requirements: Customer's Own Material (COM) requires yardage listed below.	See textile appendices for fabric families and color codes.	Price Category 1	N/C
			Price Category 2	\$ 68.
			Price Category 3	\$ 82.
			Price Category 4	\$ 101.
			Price Category 5	\$ 120.
			Price Category 7	\$ 137.
			Price Category 9	\$ 950.
			Price Category B	\$ 47.
			Price Category C	\$ 65.
			Price Category D	\$ 82.
			Price Category E	\$ 99.
			Price Category F	\$ 141.
			Price Category G	\$ 166.
Price Category H	\$ 204.			
Price Category I	\$ 264.			
Price Category J	\$ 276.			

Width of Cushion	Yards of Fabric
30"	1.05
36"	1.22
42"	1.40

When ordering more than one cushion, please round up the total yardage requirement to the next full yard of fabric.

Meridian® Stackable™ Lateral File Overhead Storage Units



Standard Pull (26)

Bar Pull (2KP)

Bevel Pull (24)

Spec-A-File

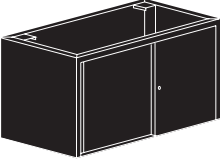
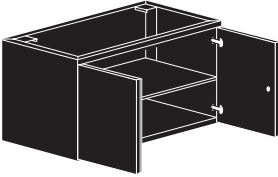
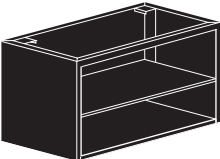



Description		Spec Code	H	D	W	Standard Pull (26)	Bar Pull (2KP)	Bevel Pull (24)
26 1/4" High								
LIST PRICE								
OS 	Overhead Storage*. Cabinet with locking sliding doors. Includes one adjustable shelf. (KA) lock options not available. Interior depth: 18" (20") and 16" (18"). Interior height: 24 1/4".	OS	26 1/4"	20"	30"	\$ 534.	N/A	N/A
					36"	\$ 609.	N/A	N/A
					42"	\$ 685.	N/A	N/A
					18" 30"	\$ 534.	N/A	N/A
					36"	\$ 609.	N/A	N/A
					42"	\$ 685.	N/A	N/A
OH 	Overhead Storage*. Cabinet with locking hinged doors. Includes one adjustable shelf. Interior depth: 18" (20") and 16" (18"). Interior height: 24 1/4".	OH	26 1/4"	20"	30"	\$ 581.	\$ 605.	\$ 581.
					36"	\$ 652.	\$ 679.	\$ 652.
					42"	\$ 731.	\$ 761.	\$ 731.
					18" 30"	\$ 581.	\$ 605.	\$ 581.
					36"	\$ 652.	\$ 679.	\$ 652.
					42"	\$ 731.	\$ 761.	\$ 731.
OB 	Overhead Storage*. Cabinet without doors. Includes one adjustable shelf. Interior depth: 18" (20") and 16" (18"). Interior height: 24 1/4".	OB	26 1/4"	20"	30"	\$ 491.	\$ 491.	N/A
					36"	\$ 569.	\$ 569.	N/A
					42"	\$ 641.	\$ 641.	N/A
					18" 30"	\$ 491.	\$ 491.	N/A
					36"	\$ 569.	\$ 569.	N/A
					42"	\$ 641.	\$ 641.	N/A
<p>Note: When ordering an overhead storage with a contour pull or bevel pull lateral file, an additional top is required if the file drawers are to lock. Call Customer Service for details.</p> <p>Application Notes: Other modules can be placed on top of an overhead storage unit only if they have a fixed shelf.</p> <p>Pull out shelves may not be used above an overhead storage unit.</p> <p>Note: Doors and drawers will be proud of this module (OB).</p>								
Additional Overhead Shelf								
Description		Spec Code	D	W	LIST PRICE			
NS 	Adjustable steel shelf with matching baked enamel finish.	NS	20" or	30"	\$ 55.			
			18"	36"	\$ 61.			
				42"	\$ 66.			

Meridian® Stackable™ Lateral File Overhead Storage Units – Multi-User Standard Pull (26)

Spec-A-File

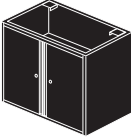

Tops	Description	Spec Code	H	D	W	Standard Pull (26)	LIST PRICE
OI 	23½" partitioned overhead storage unit with two individually locking hinged doors and one adjustable shelf per opening. Interior depth: 18" (20") and 16" (18"). Interior height: 21½".	OI	23½"	20"	30"		\$ 897.
					36"		\$ 968.
					42"		\$ 1038.
					18"	30"	\$ 897.
					36"		\$ 968.
					42"		\$ 1038.
OM 	26¼" partitioned overhead storage unit with two individually locking hinged doors and one adjustable shelf per opening. Interior depth: 18" (20") and 16" (18"). Interior height: 24¼".	OM	26¼"	20"	30"		\$ 926.
					36"		\$ 995.
					42"		\$ 1066.
					18"	30"	\$ 926.
					36"		\$ 995.
					42"		\$ 1066.

The OI and OM overhead storage units can be used in conjunction with individually locking standard pull drawer modules to create multi-user storage and filing units. Security pans between drawers are available. Modules can also be reversed. The following examples can be used as guidelines, or contact your Customer Care representative for more details on reversed module stack combinations.

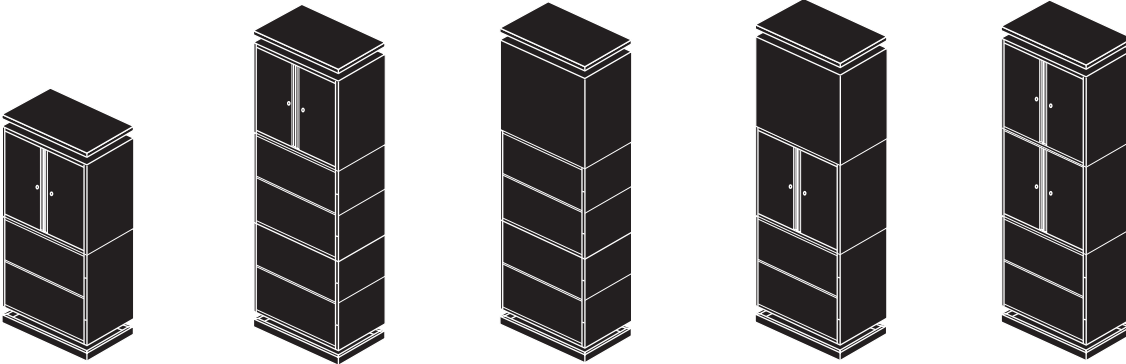

Additional Storage Shelf	Description	Spec Code	Cabinet	D	W	LIST PRICE
	Adjustable steel shelf with baked enamel finish. 15" fits one opening of 30" wide partitioned cabinet. 18" fits one opening of 36" wide partitioned cabinet. 21" fits one opening of 42" wide partitioned cabinet.	SSF-15				\$ 55.
		SSF-18				\$ 61.
		SSF-21				\$ 66.

Meridian® Stackable™ Lateral File Modules



Standard Pull (26)

Bar Pull (2KP)

Bevel Pull (24)

Spec-A-File

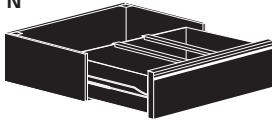
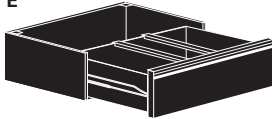

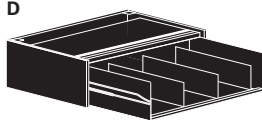
Modules	Description	Spec Code	H	D	W	Standard Pull (26)	Bar Pull (2KP)	Bevel Pull (24)
						LIST PRICE		
11³/₄" High								
N 	File drawer / fixed front. Standard 9P interior: hanging folder rails for front-to-back filing. Optional interiors: 9M, 9R, 9W-LT, 9W-LG, 9C-LT, 9C-LG. Interior depth: 17 ³ / ₄ " (20") or 15 ³ / ₄ " (18"). Interior height: 10 ⁵ / ₈ ". Hanging clearance: 9 ⁷ / ₁₆ " for 9P, 9R, 9C-LG, 9C-LT.	N	11 ³ / ₄ "	20" or 18"	30"	\$ 317.	\$ 330.	\$ 317.
					36"	\$ 346.	\$ 360.	\$ 346.
					42"	\$ 389.	\$ 408.	\$ 389.
13¹/₈" High								
E 	File drawer / fixed front. Standard 9P interior: hanging folder rails for front-to-back filing. Optional interiors: 9M, 9R, 9W-LT, 9W-LG, 9C-LT, 9C-LG. Interior depth: 17 ³ / ₄ " (20") or 15 ³ / ₄ " (18"). Interior height: 12". Hanging clearance: 9 ⁷ / ₁₆ " for 9P, 9R, 9C-LG, 9C-LT.	E	13 ¹ / ₈ "	20" or 18"	30"	\$ 317.	\$ 330.	\$ 317.
					36"	\$ 346.	\$ 360.	\$ 346.
					42"	\$ 389.	\$ 408.	\$ 389.
F 	Two half height drawers with fixed fronts. Standard 9T interior: 3 adjustable partitions per half drawer for index card filing. Interior depth: 17 ³ / ₄ " (20") or 15 ³ / ₄ " (18"). Interior height: 5 ³ / ₈ ".	F	13 ¹ / ₈ "	20" or 18"	30"	\$ 611.	\$ 636.	\$ 611.
					36"	\$ 640.	\$ 666.	\$ 640.
					42"	\$ 683.	\$ 711.	\$ 683.
C 	Fixed shelf / flip door. Standard 9M interior: 3 movable dividers for side-to-side paper folder filing. Optional interiors: 9V. Interior depth: 17 ³ / ₄ " (20") or 15 ³ / ₄ " (18"). Interior height: 10 ¹ / ₄ ".	C	13 ¹ / ₈ "	20" or 18"	30"	\$ 321.	N/A	\$ 321.
					36"	\$ 353.	N/A	\$ 353.
					42"	\$ 397.	N/A	\$ 397.
D 	Pull-out shelf / flip door. Standard 9M interior: 3 movable dividers for side-to-side paper folder filing. Optional interiors: 9Q, 9R, 9V, 9W-LT, 9W-LG, 9C-LT, 9C-LG. Interior depth: 17 ³ / ₄ " (20") or 15 ³ / ₄ " (18"). Interior height: 10 ¹ / ₄ ". Hanging clearance: 9 ⁷ / ₁₆ " for 9P, 9R, 9C-LG, 9C-LT.	D	13 ¹ / ₈ "	20" or 18"	30"	\$ 361.	N/A	\$ 361.
					36"	\$ 389.	N/A	\$ 389.
					42"	\$ 431.	N/A	\$ 431.

Meridian® Stackable™ Lateral File Modules – *Continued*



Standard Pull (26)

Bar Pull (2KP)

Bevel Pull (24)

Spec-A-File



Modules	Description	Spec Code	H	D	W	Standard Pull (26)	Bar Pull (2KP)	Bevel Pull (24)	LIST PRICE
13¹/₈" High									
J 	Open module with full back accommodates binders up to 11 ³ / ₄ " tall. Interior depth 17 ¹ / ₂ " or 19 ¹ / ₂ ". Interior height: 11 ⁷ / ₈ ". Accommodates 9Y interiors (sold separately). Note: Cannot be used as the bottom module if a counterbalance is specified. Note: Security top cannot be attached to a "J" module. Note: Door and drawers will be proud of this module (J).	J	13¹/₈"	20" or 18"	30"	\$ 400.	\$ 400.	N/A	
					36"	\$ 423.	\$ 423.	N/A	
					42"	\$ 450.	\$ 450.	N/A	
K 	Pass through unit. Interior depth: 19 ³ / ₄ " (20") or 17 ³ / ₄ " (18"). Interior height: 11 ⁷ / ₈ ". Note: Not field installable. Note: Door and drawers will be proud of this module (K).	K	13¹/₈"	20" or 18"	30"	\$ 327.	\$ 327.	N/A	
					36"	\$ 353.	\$ 353.	N/A	
					42"	\$ 399.	\$ 399.	N/A	
P 	Combination posting shelf and 11 ³ / ₄ " fixed front file pullout drawer. Standard 9P interior: hanging folder rails for front-to-back filing. Optional interiors: 9M, 9R, 9W-LT, 9W-LG, 9C-LT, 9C-LG. Interior depth: 17 ³ / ₄ " (20") or 15 ³ / ₄ " (18"). Interior height: 10 ⁵ / ₈ ". Hanging clearance: 9 ⁷ / ₁₆ " for 9P, 9R, 9C-LG, 9C-LT.	P	13¹/₈"	20" or 18"	30"	\$ 444.	N/A	N/A	
					36"	\$ 476.	N/A	N/A	
					42"	\$ 517.	N/A	N/A	

Meridian® Stackable™ Lateral File Modules – *Continued*

Standard Pull (26)

Bar Pull (2KP)

Bevel Pull (24)

Spec-A-File



Modules	Description	Spec Code	H	D	W	Standard Pull (26)	Bar Pull (2KP)	Bevel Pull (24)
LIST PRICE								
15 1/8" High								
	Fixed shelf / flip door. Standard 9M interior: 3 movable dividers for large folders and binder storage. Optional interiors: 9V. Interior depth: 17 3/4" (20") or 15 3/4" (18"). Interior height: 12 1/4". Note: Drawer front does not completely recede on 18" deep modules.	G	15 1/8"	20" or 18"	30"	\$ 456.	N/A	N/A
					36"	\$ 490.	N/A	N/A
					42"	\$ 528.	N/A	N/A
	Pullout shelf / flip door. Standard 9M interior: 3 movable dividers for large folders and binder storage. Optional interiors: 9V, 9W-LT, 9W-LG, 9X, 9Q. Interior depth: 17 3/4" (20") or 15 3/4" (18"). Interior height: 12 1/4". Hanging clearance: 9 9/16" for 9V, 11 9/16" for 9X. Note: Drawer front does not completely recede on 18" deep modules.	L	15 1/8"	20" or 18"	30"	\$ 502.	N/A	N/A
					36"	\$ 528.	N/A	N/A
					42"	\$ 577.	N/A	N/A
	File drawer / fixed front. Standard 9X interior: 2 rails for computer printout hanging binders and folders. Optional interiors: 9M, 9W-LT, 9W-LG, 9Q. To accommodate letter-width computer printout hanging binders, contact Meridian. Interior depth: 17 3/4" (20") or 15 3/4" (18"). Interior height: 14". Hanging clearance: 11 9/16" for 9X.	H	15 1/8"	20" or 18"	30"	\$ 417.	\$ 434.	\$ 417.
					36"	\$ 440.	\$ 459.	\$ 440.
					42"	\$ 485.	\$ 504.	\$ 485.
	Fixed shelf / locking sliding doors. Ideal for binder storage. Interior depth: 18" (20") or 16" (18"). Interior height: 13 1/8". (KA) lock options not available.	S	15 1/8"	20" or 18"	30"	\$ 404.	N/A	N/A
					36"	\$ 433.	N/A	N/A
					42"	\$ 482.	N/A	N/A
	Two drawers with 1 half high and 1 file drawer. Interiors available: 9P, 9M, 9R, 9W-LT, 9W-LG, 9C-LT, 9C-LG, for file drawer only. Interior file drawer depth: 17 3/4" (20") or 15 3/4" (18"). Interior height: 10 5/8". Hanging clearance: 9 7/16" for 9P, 9R, 9C-LG, and 9C-LT 15 3/4" (18"). Interior height: 10 5/8".	X	17 5/8"	20" or 18"	30"	N/A	\$ 845.	N/A
					36"	N/A	\$ 925.	N/A
					42"	N/A	\$ 1022.	N/A

Meridian® Stackable™ Lateral File Modules – *Continued*

Standard Pull (26)

Bevel Pull (24)

Spec-A-File

CD Storage*

Drawer Size	Number of CDs per Row	Number of Complete Rows per Half Drawer
30" x 18"	40	4
30" x 20"	44	4
36" x 18"	40	5
36" x 20"	44	5
42" x 18"	40	6
42" x 20"	44	6



*Calculation based on average CD size of $5\frac{5}{8}$ " x $4\frac{7}{8}$ " x $\frac{3}{8}$ ".

VHS Storage**

Drawer Size	Number of VHS Tapes per Row	Number of Complete Rows per Half Drawer
30" x 18"	12	3
30" x 20"	14	3
36" x 18"	12	4
36" x 20"	14	4
42" x 18"	12	4
42" x 20"	14	4



**Calculation based on average VHS case size of 8" x $4\frac{3}{4}$ " x $1\frac{1}{4}$ ".











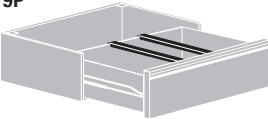

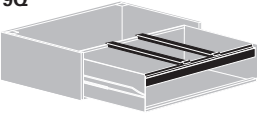

Meridian® Stackable™ Lateral Files

Interiors/Bases/Options

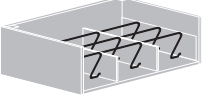
Standard Pull (26)
 Bar Pull (2KP)
 Bevel Pull (24)

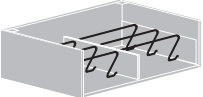
Spec-A-File

Note: Interiors 9P, 9Q, 9C-LG, 9C-LT, 9M and 9R for file drawer only in X module.

Interiors	Description	Filing Devices	Spec Code																
Front-To-Back Filing				U P C H A R G E															
9P 	Front-to-back filing rails for hanging file folders. Standard in modules: E, N, P, X.	 Hanging File Folder	9P	N/C															
9Q 	Front-to-back filing rails for hanging file folders. For use in flip door units. Optional in D, L and H modules.	 Hanging File Folder	9Q	N/C															
9C-LG 	Combination front-to-back and side-to-side rails for filing one row side-to-side legal and one row front-to-back letter of hanging file folders. Optional in modules E, N, D, P, X.	 Hanging File Folder	9C-LG	N/C															
9C-LT 	Combination front-to-back and side-to-side rails for filing one row side-to-side letter and one row front-to-back legal of hanging file folders. Optional in modules E, N, D, P, X.	 Hanging File Folder	9C-LT	N/C															
9W-LT 	Wobble dividers for filing letter size paper folders front-to-back. Optional in modules N, E, D, P, L, H.	  File Folder Expandable Pocket Folder	9W-LT	<table border="1"> <tr> <td>30" wide</td> <td>\$ 49.</td> </tr> <tr> <td>36" wide</td> <td>\$ 49.</td> </tr> <tr> <td>42" wide</td> <td>\$ 55.</td> </tr> </table>	30" wide	\$ 49.	36" wide	\$ 49.	42" wide	\$ 55.									
30" wide	\$ 49.																		
36" wide	\$ 49.																		
42" wide	\$ 55.																		
	<table border="1"> <thead> <tr> <th colspan="3">Letter</th> </tr> <tr> <th>File Width</th> <th>9M Dividers</th> <th>Letter Width Wobbles</th> </tr> </thead> <tbody> <tr> <td>30"</td> <td>4</td> <td>6</td> </tr> <tr> <td>36"</td> <td>4</td> <td>6</td> </tr> <tr> <td>42"</td> <td>6</td> <td>9</td> </tr> </tbody> </table>	Letter			File Width	9M Dividers	Letter Width Wobbles	30"	4	6	36"	4	6	42"	6	9			
Letter																			
File Width	9M Dividers	Letter Width Wobbles																	
30"	4	6																	
36"	4	6																	
42"	6	9																	
9W-LG 	Wobble dividers for filing legal size paper folders front-to-back. Optional in modules N, E, D, P, L, H.	 File Folder	9W-LG	<table border="1"> <tr> <td>30" wide</td> <td>\$ 49.</td> </tr> <tr> <td>36" wide</td> <td>\$ 55.</td> </tr> <tr> <td>42" wide</td> <td>\$ 55.</td> </tr> </table>	30" wide	\$ 49.	36" wide	\$ 55.	42" wide	\$ 55.									
30" wide	\$ 49.																		
36" wide	\$ 55.																		
42" wide	\$ 55.																		
	<table border="1"> <thead> <tr> <th colspan="3">Legal</th> </tr> <tr> <th>File Width</th> <th>9M Dividers</th> <th>Legal Width Wobbles</th> </tr> </thead> <tbody> <tr> <td>30"</td> <td>2</td> <td>3</td> </tr> <tr> <td>36"</td> <td>4</td> <td>6</td> </tr> <tr> <td>42"</td> <td>4</td> <td>6</td> </tr> </tbody> </table>	Legal			File Width	9M Dividers	Legal Width Wobbles	30"	2	3	36"	4	6	42"	4	6			
Legal																			
File Width	9M Dividers	Legal Width Wobbles																	
30"	2	3																	
36"	4	6																	
42"	4	6																	
9T 	Set of six movable partitions, 3 per half-height drawer. Standard in modules F and B only.		9T	N/C															
9Y 	Three movable magnetic dividers for large binder storage. Side-to-Side Filing only. 12" H X 5"W X 16" D Standard in A module only.		9Y	N/C															

Meridian® Stackable™ Lateral Files

Interiors/Bases/Options – Continued











Standard Pull (26)





Bar Pull (2KP)

Bevel Pull (24)

Spec-A-File

Note: Interiors 9P, 9Q, 9C-LG, 9C-LT, 9M and 9R for file drawer only in X module.

Interiors	Description	Filing Devices	Spec Code	
Side-To-Side Filing				U P C H A R G E
9M 	Three movable dividers for filing paper folders. Standard in modules: C, D, G, L. Optional in modules: E, N, H, P, X.	 File Folder  Binder  Expandable Pocket Folder	9M	N/C
9R 	Side-to-side rails for hanging file folders (letter, legal, A-4, foolscap). Optional in modules: E, N, D, H, P, X. 1 required for E, N, and P modules. 2 required for D and H modules.	 Hanging File Folder	9R	N/C
9V 	Movable dividers (9M) with side-to-side rail (9R) for tab style side-to-side filing. Optional in modules: C, D, G, L.	 File Folder	9V	N/C
9X 	Side-to-side filing rails for computer printout hanging binders and folders, 2 rails included. Standard in H module. Optional in L module.	 Standard Hanging Computer Paper Folder	9X	N/C

Bases / Options	Description	Spec Code	H	D	W	LIST PRICE	
Bases 	Frame-type steel base with baked enamel finish. Includes four adjustable leveling glides.	B1	1"	20" or 18"	30"	\$ 79.	
		B2	1 1/2"		36"	\$ 94.	
		B3	2 1/4"		42"	\$ 109.	
		B4	3 1/4"				
		B5	4 1/4"	20" or 18"	30"	\$ 115.	
Leg Bases with Legs 	Frame-type steel base with baked enamel finish. Includes four Canvas-style legs. Note: Legs must be field installed. Not available for Contour Pull (25).	LB2DD	1 1/2"	20" or 18"	30"	\$ 237.	
					36"	\$ 254.	
					42"	\$ 268.	
Recessed Bases 	Frame-type steel base with baked enamel finish. Recessed 1 1/16". Includes four adjustable leveling glides.	BA	1"	20" or 18"	30"	\$ 115.	
		BB	1 1/2"		36"	\$ 132.	
		BC	2 1/4"		42"	\$ 146.	
		BD	3 1/4"				
Lock	Flush lock. Locks are located in the module frame in the standard pull lateral file. Locks are located in the top in the bevel pull and contour pull lateral files.	KD, KC, or KA				\$ 38.	
Counterbalance Weight	Recommended for 2 and 3-high lateral files.	CB Add \$75 to Counterweight price for 1-high freestanding lateral modules N, E, D, P, L and H				\$ 124.	
Security Pan 	Flat steel pan placed between modules of a lateral file stack. For use on B, C, D, E, F, G, H, L, N, P, X modules. Available through Advanced Spec-A-File. Contact Customer Care for information	PN	1/32"	20" or 18"	30"	\$ 45.	
					36"	\$ 51.	
					42"	\$ 60.	
Note: List price upcharge is for quantity 1 security pan.							

Meridian® Stackable™ Lateral Files Retrofit Interiors

The prices below are the retrofit prices for field installing these interiors in appropriate **existing** lateral file drawers. Option includes all parts and instructions. Be certain to specify the "part" number corresponding to the width and depth of file to be fitted.

Description		Part Number			Description		Part Number		
Front-To-Back Filing			LIST	PRICE	Side-To-Side Filing			LIST	PRICE
9P	30" x 18"	9P0018	\$	27.	9M ea	All 18"	9M10018	\$	14.
9P	36" x 18"	9P3618	\$	27.	9M ea	All 20"	9M10020	\$	14.
9P	42" x 18"	9P0018	\$	27.	9M set of 3	All 18"	9M30018	\$	34.
9P	30" x 20"	9P0020	\$	27.	9M set of 3	All 20"	9M30020	\$	34.
9P	36" x 20"	9P3620	\$	27.	9R ea	30" x 18/20"	9R13000	\$	20.
9P	42" x 20"	9P0020	\$	27.	9R ea	36" x 18/20"	9R13600	\$	20.
9Q	30" x 18"	9Q3018	\$	44.	9R ea	42" x 18/20"	9R14200	\$	20.
9Q	36" x 18"	9Q3618	\$	44.	9R set of 2	30" x 18/20"	9R23000	\$	40.
9Q	42" x 18"	9Q4218	\$	44.	9R set of 2	36" x 18/20"	9R23600	\$	40.
9Q	30" x 20"	9Q3020	\$	44.	9R set of 2	42" x 18/20"	9R24200	\$	40.
9Q	36" x 20"	9Q3620	\$	44.	9V	30" x 18"	9V3018	\$	44.
9Q	42" x 20"	9Q4220	\$	44.	9V	36" x 18"	9V3618	\$	44.
9C-LT	30" x 18/20"	9C3000LT	\$	44.	9V	42" x 18"	9V4218	\$	44.
9C-LT	36" x 18/20"	9C3600LT	\$	44.	9V	30" x 20"	9V3020	\$	44.
9C-LT	42" x 18/20"	9C4200LT	\$	44.	9V	36" x 20"	9V3620	\$	44.
9C-LG	30" x 18/20"	9C3000LG	\$	44.	9V	42" x 20"	9V4220	\$	44.
9C-LG	36" x 18/20"	9C3600LG	\$	44.	9X	30" x 18/20"	9X3000	\$	38.
9C-LG	42" x 18/20"	9C4200LG	\$	44.	9X	36" x 18/20"	9X3600	\$	38.
9W-LT	30"/36" x 18"	9W0018LT	\$	84.	9X	42" x 18/20"	9X4200	\$	38.
9W-LT	42" x 18"	9W4218LT	\$	92.	9Y ea	12"Hx5"Wx16"D	9Y10000	\$	39.
9W-LT	30"/36" x 20"	9W0020LT	\$	84.					
9W-LT	42" x 20"	9W4220LT	\$	92.					
9W-LG	30" x 18"	9W3018LG	\$	84.					
9W-LG	36"/42" x 18"	9W0018LG	\$	92.					
9W-LG	30" x 20"	9W3020LG	\$	84.					
9W-LG	36"/42" x 20"	9W0020LG	\$	92.					
9T ea	All 18"	9T10018	\$	14.					
9T ea	All 20"	9T10020	\$	14.					
9T set of 6	All 18"	9T60018	\$	59.					
9T set of 6	All 20"	9T60020	\$	59.					

* Specify paint color

Meridian® Stackable™ Lateral Files Card Tray

Card Tray Interior

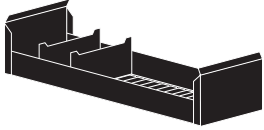

Description

Consists of removable card tray with 2 5¹/₂" dividers for card filing. To be used only with modules F and B. Partial bottom with open center.

Card Trays (all sizes)

LIST PRICE

\$ 55.

Card Tray Interiors

Actual Dimension	Card Size	File Depth	Item No.	Drawer Width	Trays Per Drawer
5 ³ / ₈ " w x 15 ³ / ₈ " d x 5 ¹ / ₄ " h	3 x 5	18"	CT-3518	30"	4
				36"	6
				42"	7
5 ³ / ₈ " w x 17 ³ / ₈ " d x 5 ¹ / ₄ " h		20"	CT-3520	30"	4
				36"	6
				42"	7
6 ³ / ₈ " w x 15 ³ / ₈ " d x 5 ¹ / ₄ " h	4 x 6	18"	CT-4618	30"	4
				36"	5
				42"	6
6 ³ / ₈ " w x 17 ³ / ₈ " d x 5 ¹ / ₄ " h		20"	CT-4620	30"	4
				36"	5
				42"	6
8 ³ / ₈ " w x 15 ³ / ₈ " d x 5 ¹ / ₄ " h	5 x 8	18"	CT-5818	30"	3
				36"	3
				42"	4
8 ³ / ₈ " w x 17 ³ / ₈ " d x 5 ¹ / ₄ " h		20"	CT-5820	30"	3
				36"	3
				42"	4
9 ³ / ₈ " w x 15 ³ / ₈ " d x 5 ¹ / ₄ " h	4 x 9	18"	CT-4918	30"	2
				36"	3
				42"	4
9 ³ / ₈ " w x 17 ³ / ₈ " d x 5 ¹ / ₄ " h		20"	CT-4920	30"	2
				36"	3
				42"	4

Meridian® Stackable™ Lateral Files Accessories

	Description	D	H	W	Item Number	Quantity	LIST PRICE
Movable Magnetic Divider 	Movable magnetic divider for storage of miscellaneous media. Side-to-side filing only. Available in black.	8"	9"		9Y10809	1	\$ 39.
		13"	12"		9Y11312	1	\$ 48.
		15"	9"		9Y11509	1	\$ 48.

File Drawer Organizer 	This two-sectioned organizer fits into any file drawer arranged for letter-size filing. The removable top section stores computer disks and other small items. The bottom section stores larger items or can be divided into 3 compartments; it includes 2 vertical dividers. Finish is black umber.	6"	9"	12 ⁷ / ₈ "	LG901.		\$ 77.
---	--	----	----	----------------------------------	--------	--	--------

Note: This organizer does not accept letter-size file folders.

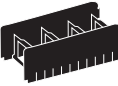
Multi-Media Index Divider 	Multi-media index dividers for a variety of media types including diskettes, CD-ROMs, microfiche, microfilm and index cards. Includes 2 9T front-to-back dividers and 4 index dividers.	18"	3"	3"	A128-030318		\$ 58.
		20"	3"	3"	A128-030320		\$ 58.
		18"	3"	5"	A128-030518		\$ 58.
		20"	3"	5"	A128-030520		\$ 58.
		18"	4"	6"	A128-040618		\$ 58.
		20"	4"	6"	A128-040620		\$ 58.
		18"	6"	5"	A128-060518		\$ 58.
20"	6"	5"	A128-060520		\$ 58.		

EnhancedAccess™ Pulls  Loop Style	These plastic loop-style pulls slide into the standard pulls on pedestal or lateral file drawers. They make the drawers easier to open. Package contains 1 pull and attachment hardware.	Loop Style			EAP-L		\$ 54.
--	--	------------	--	--	-------	--	--------

For use with standard pull modules only.

Available in:

Black UMBER **BU**
 Inner Tone Light **HF**
 Medium Tone **MT**

Freestanding Stackable™ Lateral Files

Mobile Stackable™ Lateral Files

File Tops

File Surrounds

Stackable™ Lateral File Accessories



Standard-Pull Freestanding Lateral File

26-30
26-36
26-42

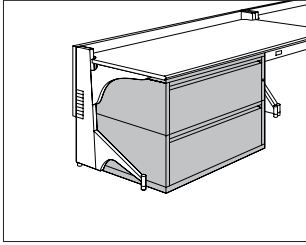

Product Information

Description

This lateral file holds letter-, legal-, and A4-size hanging files. It has standard pulls and smooth or textured steel. The file has no top or a metal, cushion, laminate, planter, or veneer top. A positive interlock system permits only 1 drawer to open at a time. 1 lock controls all drawers. The drawers can be specified with 3 dividers or with front-to-back or side-to-side filing rails for hanging files. The 5-high lateral file has 4 drawers and 1 flipper door; the flipper door includes a pullout shelf with 3 movable dividers. 5 base heights are available; all bases include adjustable glides.

Actual lateral file widths are 29⁷/₈" , 35⁷/₈" , or 41⁷/₈" ; actual depths are 17⁷/₈" or 19⁷/₈" .

Notes

For 2- or 3-high files that are not ganged or anchored, counterweights (option CB) are required. For 4- or 5-high files that are not ganged or anchored, counterweights are recommended.

When alternate drawer interior (9P, 9R, or 9M) is specified for 5-high lateral file, pullout shelf still includes 3 movable dividers.

For base height option (LB2), legs will be shipped separately.

For base height option (LB2), overall height is 3¹/₂" consisting of 1¹/₂" tube base with 2" legs.

Dimensional illustrations do not include all possible configurations.

To convert filing direction, order 1 of the following products separately:

- Front-to-back rail (9Pxxxx)
- Side-to-side rail (9Rxxxxx)

See Stackable Lateral File Accessories for specific product number.

Order optional file drawer organizer (LG901) separately.

For work surface on top of 1 or more lateral files, order file top (TPL or TPV) separately.

For cushion tops TC1 and TC2, a 1" metal top is included.

Cushion top accepts Customer's Own Material (COM). Yardage is estimated for nondirectional, 54"-wide fabrics. When ordering more than 1 cushion, round up total yardage requirement to next whole yard of fabric.

Width—Yardage

30" —1.05

36" —1.22

42" —1.40

For information on multiple quantities or directional fabrics, contact COM Department. See Order Information in Appendices.

For keyed-alike locks, order lock plugs separately. See Keyed-Alike Information in Appendices.

Dimensions

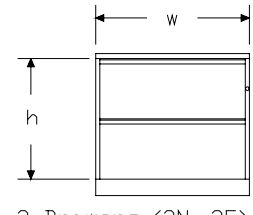
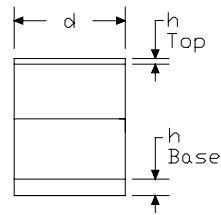

2 Drawers (2N, 2E)

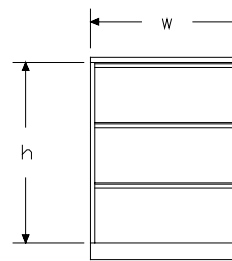

3 Drawers (3N, 3E)

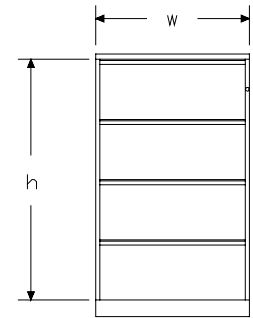

4 Drawers (4N, 4E)

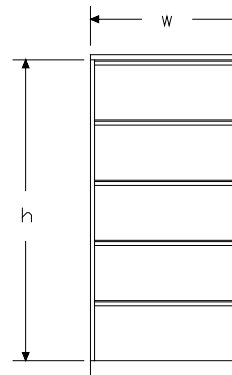

5 Drawers (5N)

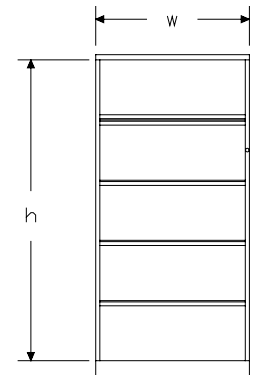

1 Flipper Door and 4 Drawers (5D, 5F)

h	N	E	D	F
2	23 1/2	26 1/4	-	-
3	35 1/4	39 3/8	-	-
4	47	52 1/2	-	-
5	58 3/4	-	60 1/8	65 5/8

All dimensions are in inches.

Standard-Pull Freestanding Lateral File *continued*

Specification Information	
Step 1.	
26-	
Step 2. Width	
30	30" wide
36	36" wide
42	42" wide
Step 3. Depth	
18-	18" deep
20-	20" deep
Step 4. Configuration	
2N	2 11 ³ / ₄ "-high drawers
3N	3 11 ³ / ₄ "-high drawers
4N	4 11 ³ / ₄ "-high drawers
5N	5 11 ³ / ₄ "-high drawers
5D	1 13 ¹ / ₈ "-high flipper door and 4 11 ³ / ₄ "-high drawers
2E	2 13 ¹ / ₈ "-high drawers
3E	3 13 ¹ / ₈ "-high drawers
4E	4 13 ¹ / ₈ "-high drawers
5F	1 13 ¹ / ₈ "-high flipper door and 4 13 ¹ / ₈ "-high drawers

Prices for Steps 1-4.							
		2N	3N	4N	5N	5D	2E
26-30	18-	\$802	1115	1430	1744	1789	802
	20-	\$802	1115	1430	1744	1789	802
26-36	18-	\$889	1232	1576	1919	1963	889
	20-	\$889	1232	1576	1919	1963	889
26-42	18-	\$1008	1394	1781	2170	2212	1008
	20-	\$1008	1394	1781	2170	2212	1008
				3E	4E	5F	
26-30	18-			\$1115	1430	1789	
	20-			\$1115	1430	1789	
26-36	18-			\$1232	1576	1963	
	20-			\$1232	1576	1963	
26-42	18-			\$1394	1781	2212	
	20-			\$1394	1781	2212	

Step 5. Paint/Steel Type		
SS	smooth paint on smooth steel	+\$0
TS	smooth paint on textured steel	+\$35
XS	textured paint on smooth steel	+\$0

Step 6. Surface Finish		
Nonmetallic Paint		
<i>For smooth paint on smooth steel (SS) or smooth paint on textured steel (TS)</i>		
8Q	folkstone grey	+\$0
91	white	+\$0
98	studio white A	+\$0
9J	sparrow	+\$0
BU	black umber	+\$0
CL	cool grey neutral	+\$0
G2	graphite satin	+\$0
HF	inner tone light	+\$0
HT	inner tone	+\$0
LT	light tone	+\$0
LU	soft white	+\$0
MT	medium tone	+\$0
SG	slate grey	+\$0
WA	wheat	+\$0
WL	sandstone	+\$0

Metallic Paint		
<i>For smooth paint on smooth steel (SS) or smooth paint on textured steel (TS)</i>		
1209	platinum	+\$65
1210	hematite	+\$65
1212	bronzite	+\$65
CN	metallic champagne	+\$65
EH	metallic bronze	+\$65
MS	metallic silver	+\$65

Sand Texture Paint		
<i>For textured paint on smooth steel (XS)</i>		
98	studio white A	+\$0

Bright Sand Texture Paint		
<i>For textured paint on smooth steel (XS)</i>		
91	white	+\$0
CL	cool grey neutral	+\$0
G1	graphite	+\$0
WN	warm grey neutral	+\$0

Standard-Pull Freestanding Lateral File *continued*

Step 7. Top		
NT	no top	+\$0
T1	1"-high painted metal top with squared edge	+\$0
T2	1¼"-high painted metal top with squared edge	+\$0
T3	1¼"-high painted metal top with radius edge	+\$63
TL	1¼"-high laminate top with thermoplastic edge	+\$72
TR	1¼"-high recut veneer top <input type="checkbox"/> A	+\$147
TF	1¼"-high wood veneer top <input type="checkbox"/> A	+\$152
T7	6½"-high planter top	+\$196
D1	6½"-high full dome, side-to-side	+\$267
H1	6½"-high half dome, sloping left	+\$267
H2	6½"-high half dome, sloping right	+\$267
TV1	1⅛"-high wood veneer top and wood composite edge with oversail front <input type="checkbox"/> A	+\$314
TC1	1" cushion top	+\$386
TC2	2" cushion top	+\$386

Step 8. Veneer Top Finish

Wood Veneer

For 1⅛"-high wood veneer top and wood composite edge with oversail front (TV1)

40	dark brown walnut <input type="checkbox"/> A	+\$28
ED	aged cherry <input type="checkbox"/> A	+\$28
EK	medium red walnut <input type="checkbox"/> A	+\$28
EW	medium matte walnut <input type="checkbox"/> A	+\$28
ET	clear on ash <input type="checkbox"/> A	+\$28
EU	oak on ash <input type="checkbox"/> A	+\$28
EV	walnut on ash <input type="checkbox"/> A	+\$28
UL	natural maple <input type="checkbox"/> A	+\$28
UX	walnut on cherry <input type="checkbox"/> A	+\$28

Wood Veneer

For 1¼"-high wood veneer top (TF)

2U	light brown walnut <input type="checkbox"/> A	+\$28
40	dark brown walnut <input type="checkbox"/> A	+\$28
ED	aged cherry <input type="checkbox"/> A	+\$28
EK	medium red walnut <input type="checkbox"/> A	+\$28
EW	medium matte walnut <input type="checkbox"/> A	+\$28
ET	clear on ash <input type="checkbox"/> A	+\$28
EU	oak on ash <input type="checkbox"/> A	+\$28
EV	walnut on ash <input type="checkbox"/> A	+\$28
UL	natural maple <input type="checkbox"/> A	+\$28
UX	walnut on cherry <input type="checkbox"/> A	+\$28

Recut Veneer

For 1¼"-high recut veneer top (TR)

RA	light ash <input type="checkbox"/> A	+\$0
RK	mahogany dark <input type="checkbox"/> A	+\$0
RM	mahogany <input type="checkbox"/> A	+\$0

Step 9. Top Finish

For 1¼"-high laminate top with thermoplastic edge (TL)

Solid-Color Laminate

8Q	folkstone grey	+\$0
91	white	+\$0
98	studio white	+\$0
CL	cool grey neutral	+\$0
HF	inner tone light	+\$0
HT	inner tone	+\$0
LT	light tone	+\$0
LU	soft white	+\$0
WL	sandstone	+\$0
WN	warm grey neutral	+\$0

Linen Laminate

LBM	crisp linen	+\$0
LBN	classic linen	+\$0
LBP	casual linen	+\$0

Mesh Laminate

LBK	pewter mesh	+\$0
LBL	steel mesh	+\$0

Twill Laminate

LBF	neutral twill	+\$0
LBG	sarum twill	+\$0
LBH	earthen twill	+\$0
LBJ	graphite twill	+\$0
LBQ	white twill	+\$0

Standard-Pull Freestanding Lateral File *continued*

Meridian® Freestanding Stackable™ Lateral Files

Wood-Grain Laminate		
HM	natural maple	+\$0
HP	light anigre	+\$0
LA	light ash	+\$0
LBA	clear on ash	+\$0
LBB	oak on ash	+\$0
LBC	walnut on ash	+\$0
LBD	dark brown walnut	+\$0
LBR	phantom ecru	+\$0
LBS	phantom cocoa	+\$0
LBU	medium matte walnut	+\$0
LBV	warm grey teak	+\$0
LBE	medium red walnut	+\$0
LM	mahogany	+\$0
76	light brown walnut	+\$0
HX	aged cherry	+\$0
HY	walnut on cherry	+\$0

Zephyr Laminate		
28	canyon	+\$0
29	misted	+\$0

Step 10. Edge Finish		
<i>For 1 1/4"-high laminate top with thermoplastic edge (TL)</i>		
28	canyon	+\$0
29	misted	+\$0
76	light brown walnut	+\$0
8Q	folkstone grey	+\$0
91	white	+\$0
BU	black umber	+\$0
CL	cool grey neutral	+\$0
G2	graphite satin	+\$0
HF	inner tone light	+\$0
HM	natural maple	+\$0
HP	light anigre	+\$0
HT	inner tone	+\$0
HX	aged cherry	+\$0
HY	walnut on cherry	+\$0
LA	light ash	+\$0
LBA	clear on ash	+\$0
LBB	oak on ash	+\$0
LBC	walnut on ash	+\$0
LBD	dark brown walnut	+\$0
LBR	phantom ecru	+\$0
LBS	phantom cocoa	+\$0
LBU	medium matte walnut	+\$0
LBV	warm grey teak	+\$0

LBE	medium red walnut	+\$0
LBK	pewter mesh	+\$0
LBL	steel mesh	+\$0
LBM	crisp linen	+\$0
LBN	classic linen	+\$0
LBP	casual linen	+\$0
LBF	neutral twill	+\$0
LBG	sarum twill	+\$0
LBH	earthen twill	+\$0
LBJ	graphite twill	+\$0
LBQ	white twill	+\$0
LM	mahogany	+\$0
LU	soft white	+\$0
MT	medium tone	+\$0
SG	slate grey	+\$0
WA	wheat	+\$0
WL	sandstone	+\$0
WN	warm grey neutral	+\$0

Step 11. Cushion Top Fabric

For 1" cushion top (TC1) or 2" cushion top (TC2)

See application chart and textiles list for fabric usage and numbers.

First 2 digits of number indicate fabric line; remaining digit(s) indicate fabric color.

Price Category 1	+\$0
Price Category 2	+\$68
Price Category 3	+\$82
Price Category 4	+\$101
Price Category 7 A	+\$137
Price Category 9	+\$950
Price Category B	+\$47
Price Category E	+\$99
Price Category G	+\$166
Price Category H	+\$204

Step 12. Lock

KA	keyed alike	+\$0
KC	keyed differently, chrome	+\$0
KD	keyed differently, black	+\$0

Standard-Pull Freestanding Lateral File *continued*

Step 13. Base Height		
B1	1"-high base	+\$0
B2	1½"-high base	+\$0
B3	2¼"-high base	+\$0
B4	3¼"-high base	+\$0
BA	1"-high recessed base	+\$33
BB	1½"-high recessed base	+\$33
BC	2¼"-high recessed base	+\$33
BD	3¼"-high recessed base	+\$33
B5	4¼"-high base	+\$33
LB2	1½" leg base	+\$33

Step 14. Leg <i>For 1½" leg base (LB2)</i>		
DD	2"-high canvas leg	+\$122

Step 15. Leg Finish		
91	white	+\$0
98	studio white	+\$0
CL	cool grey neutral	+\$0
G1	graphite	+\$0
WN	warm grey neutral	+\$0

Metallic Paint		
CN	metallic champagne	+\$10
EH	metallic bronze	+\$10
MS	metallic silver	+\$10

Step 16. Counterweight		
NO	no counterweight (must gang or anchor)	+\$0
CB	counterweight (recommended)	+\$119

Step 17. Drawer Interior		
9M	3 dividers	+\$0
9P	front-to-back filing rail	+\$0
9R	side-to-side filing rail	+\$0

Arc-Pull Freestanding Lateral File

2A-30
2A-36
2A-42
2D-30
2D-36
2D-42

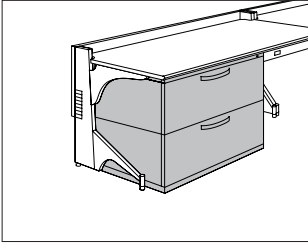

Product Information

Description

This lateral file holds letter-, legal-, and A4-size hanging files. It has arc pulls and smooth or textured steel. The file has no top or a metal, cushion, laminate, planter, or veneer top. A positive interlock system permits only 1 drawer to open at a time. 1 lock controls all drawers. The drawers can be specified with 3 dividers or with front-to-back or side-to-side filing rails for hanging files. 5 base heights are available; all bases include adjustable glides.

Actual lateral file widths are $29\frac{7}{8}$ " , $35\frac{7}{8}$ " , or $41\frac{7}{8}$ " ; actual depths are $17\frac{7}{8}$ " or $19\frac{7}{8}$ " .

Notes

For 2- or 3-high files that are not ganged or anchored, counterweights (option CB) are required. For 4- or 5-high files that are not ganged or anchored, counterweights are recommended.

For base height option (LB2), legs will be shipped separately.

For base height option (LB2), overall height is $3\frac{1}{2}$ " consisting of $1\frac{1}{2}$ " tube base with 2" legs.

Dimensional illustrations do not include all possible configurations.

To convert filing direction, order 1 of the following products separately:

- Front-to-back rail (gPxxxx)
- Side-to-side rail (gRxxxx)

See Stackable Lateral File Accessories for specific product number.

Order optional file drawer organizer (LG901) separately.

For work surface on top of 1 or more lateral files, order file top (TPL or TPV) separately.

No lock option (NL) can only be specified on files with no top (NT), dome tops (D1, H1, or H2), planter top (T7), laminate tops (TL), or veneer top (TV1).

For cushion tops TC1 and TC2, a 1" metal top is included.

Grain direction is vertical for veneer-front lateral files.

Cushion top accepts Customer's Own Material (COM). Yardage is estimated for nondirectional, 54"-wide fabrics. When ordering more than 1 cushion, round up total yardage requirement to next whole yard of fabric.

Width—Yardage

30" —1.05

36" —1.22

42" —1.40

For information on multiple quantities or directional fabrics, contact COM Department. See Order Information in Appendices.

For keyed-alike locks, order lock plugs separately. See Keyed-Alike Information in Appendices.

The arc pull conforms to guidelines of the Americans with Disabilities Act (ADA).

Dimensions

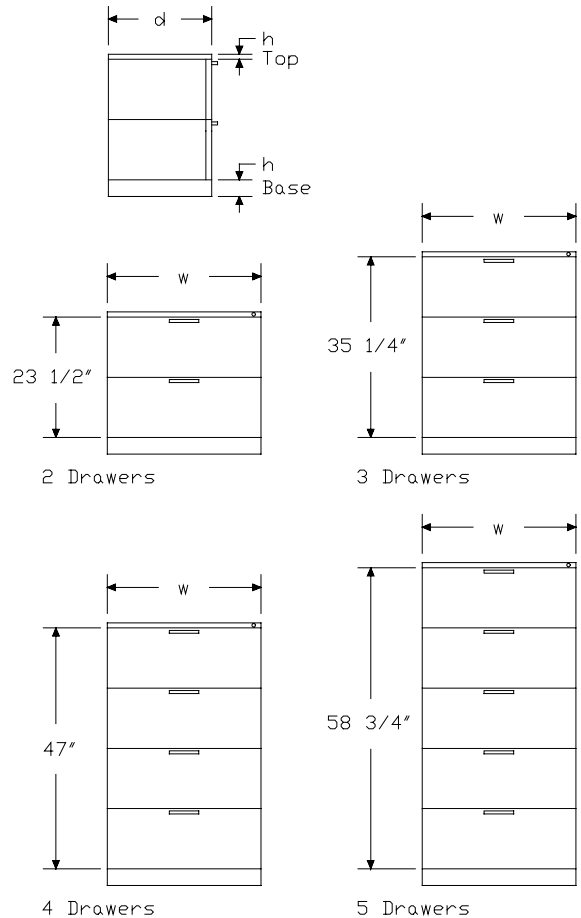

Arc-Pull Freestanding Lateral File

continued

Meridian® Freestanding Stackable™ Lateral Files

Specification Information

Step 1.

2

Step 2. Front Material

- D- painted metal front
- A- veneer front A

Step 3. Width

- 30 30" wide
- 36 36" wide
- 42 42" wide

Step 4. Depth

- 18- 18" deep
- 20- 20" deep

Step 5. Configuration

- 2N 2 drawers
- 3N 3 drawers
- 4N 4 drawers
- 5N 5 drawers

Prices for Steps 1-5.

	2N	3N	4N	5N
2D-30 18-	\$843	1156	1471	1785
20-	\$843	1156	1471	1785
2D-36 18-	\$931	1274	1618	1961
20-	\$931	1274	1618	1961
2D-42 18-	\$1049	1435	1823	2211
20-	\$1049	1435	1823	2211
2A-30 18-	\$1170	1650	2126	2607
20-	\$1170	1650	2126	2607
2A-36 18-	\$1324	1865	2406	2946
20-	\$1324	1865	2406	2946
2A-42 18-	\$1504	2119	2737	3351
20-	\$1504	2119	2737	3351

Step 6. Paint/Steel Type

- SS smooth paint on smooth steel +\$0
- TS smooth paint on textured steel +\$35
- XS textured paint on smooth steel +\$0

Step 7. Surface Finish

Nonmetallic Paint

For smooth paint on smooth steel (SS) or smooth paint on textured steel (TS)

- 8Q folkstone grey +\$0
- 91 white +\$0
- 98 studio white A +\$0
- 9J sparrow +\$0
- BU black umber +\$0
- G2 graphite satin +\$0
- HF inner tone light +\$0
- HT inner tone +\$0
- LT light tone +\$0
- LU soft white +\$0
- MT medium tone +\$0
- SG slate grey +\$0
- WA wheat +\$0
- WL sandstone +\$0

Metallic Paint

For smooth paint on smooth steel (SS) or smooth paint on textured steel (TS)

- 1209 platinum +\$65
- 1210 hematite +\$65
- 1212 bronzite +\$65
- CN metallic champagne +\$65
- EH metallic bronze +\$65
- MS metallic silver +\$65

Sand Texture Paint

For textured paint on smooth steel (XS)

- 98 studio white A +\$0

Bright Sand Texture Paint

For textured paint on smooth steel (XS)

- 91 white +\$0
- CL cool grey neutral +\$0
- G1 graphite +\$0
- WN warm grey neutral +\$0

Arc-Pull Freestanding Lateral File

continued

Step 8. Top

For painted metal front (D-)

NT	no top	+\$0
T1	1"-high painted metal top with squared edge	+\$0
T2	1¼"-high painted metal top with squared edge	+\$0
T3	1¼"-high painted metal top with radius edge	+\$63
TL	1¼"-high laminate top with thermoplastic edge	+\$72
TR	1¼"-high recut veneer top A	+\$147
TF	1¼"-high wood veneer top A	+\$152
T7	6½"-high planter top	+\$196
D1	6½"-high full dome, side-to-side	+\$267
H1	6½"-high half dome, sloping left	+\$267
H2	6½"-high half dome, sloping right	+\$267
TV1	1⅛"-high wood veneer top and wood composite edge with oversail front A	+\$314
TC1	1" cushion top	+\$386
TC2	2" cushion top	+\$386

For veneer front (A-)

NT	no top	+\$0
T1	1"-high painted metal top with squared edge	+\$0
T2	1¼"-high painted metal top with squared edge	+\$0
T3	1¼"-high painted metal top with radius edge	+\$63
TL	1¼"-high laminate top with thermoplastic edge	+\$72
TF	1¼"-high wood veneer top A	+\$152
T7	6½"-high planter top	+\$196
D1	6½"-high full dome, side-to-side	+\$267
H1	6½"-high half dome, sloping left	+\$267
H2	6½"-high half dome, sloping right	+\$267
TV1	1⅛"-high wood veneer top and wood composite edge with oversail front A	+\$314
TC1	1" cushion top	+\$386
TC2	2" cushion top	+\$386

Step 9.

Veneer Top Finish: Wood Veneer

For 1¼"-high wood veneer top (TF)

2U	light brown walnut A	+\$28
40	dark brown walnut A	+\$28
ED	aged cherry A	+\$28
EK	medium red walnut A	+\$28
EW	medium matte walnut A	+\$28
ET	clear on ash A	+\$28
EU	oak on ash A	+\$28
EV	walnut on ash A	+\$28
UL	natural maple A	+\$28
UX	walnut on cherry A	+\$28

Veneer Front Finish: Wood Veneer

For no top (NT), 1"-high painted metal top with squared edge (T1), 1¼"-high painted metal top with squared edge (T2), 1¼"-high painted metal top with radius edge (T3), 1¼"-high laminate top with thermoplastic edge (TL), 6½"-high planter top (T7), 6½"-high full dome, side-to-side (D1), 6½"-high half dome, sloping left (H1), 6½"-high half dome, sloping right (H2), 1" cushion top (TC1), or 2" cushion top (TC2)

2U	light brown walnut A	+\$56
40	dark brown walnut A	+\$56
ED	aged cherry A	+\$56
EK	medium red walnut A	+\$56
EW	medium matte walnut A	+\$56
ET	clear on ash A	+\$56
EU	oak on ash A	+\$56
EV	walnut on ash A	+\$56
UL	natural maple A	+\$56
UX	walnut on cherry A	+\$56

Veneer Top Finish: Wood Veneer

For 1⅛"-high wood veneer top and wood composite edge with oversail front (TV1)

40	dark brown walnut A	+\$28
ED	aged cherry A	+\$28
EK	medium red walnut A	+\$28
EW	medium matte walnut A	+\$28
ET	clear on ash A	+\$28
EU	oak on ash A	+\$28
EV	walnut on ash A	+\$28
UL	natural maple A	+\$28
UX	walnut on cherry A	+\$28

Arc-Pull Freestanding Lateral File

continued

Veneer Front/Top Finish: Wood Veneer

For 1¹/₈"-high wood veneer top and wood composite edge with oversail front (TV₁)

40	dark brown walnut <input type="checkbox"/>	+\$56
ED	aged cherry <input type="checkbox"/>	+\$56
EK	medium red walnut <input type="checkbox"/>	+\$56
EW	medium matte walnut <input type="checkbox"/>	+\$56
ET	clear on ash <input type="checkbox"/>	+\$56
EU	oak on ash <input type="checkbox"/>	+\$56
EV	walnut on ash <input type="checkbox"/>	+\$56
UL	natural maple <input type="checkbox"/>	+\$56
UX	walnut on cherry <input type="checkbox"/>	+\$56

Veneer Top Finish: Recut Veneer

For 1¹/₄"-high recut veneer top (TR)

RA	light ash <input type="checkbox"/>	+\$0
RK	mahogany dark <input type="checkbox"/>	+\$0
RM	mahogany <input type="checkbox"/>	+\$0

Veneer Front/Top Finish: Wood Veneer

For 1¹/₄"-high wood veneer top (TF)

2U	light brown walnut <input type="checkbox"/>	+\$56
40	dark brown walnut <input type="checkbox"/>	+\$56
ED	aged cherry <input type="checkbox"/>	+\$56
EK	medium red walnut <input type="checkbox"/>	+\$56
EW	medium matte walnut <input type="checkbox"/>	+\$56
ET	clear on ash <input type="checkbox"/>	+\$56
EU	oak on ash <input type="checkbox"/>	+\$56
EV	walnut on ash <input type="checkbox"/>	+\$56
UL	natural maple <input type="checkbox"/>	+\$56
UX	walnut on cherry <input type="checkbox"/>	+\$56

Step 10. Top Finish

For 1¹/₄"-high laminate top with thermoplastic edge (TL)

Solid-Color Laminate

8Q	folkstone grey	+\$0
91	white	+\$0
98	studio white	+\$0
CL	cool grey neutral	+\$0
HF	inner tone light	+\$0
HT	inner tone	+\$0
LT	light tone	+\$0
LU	soft white	+\$0
WL	sandstone	+\$0
WN	warm grey neutral	+\$0

Linen Laminate

LBM	crisp linen	+\$0
LBN	classic linen	+\$0
LBP	casual linen	+\$0

Mesh Laminate

LBK	pewter mesh	+\$0
LBL	steel mesh	+\$0

Twill Laminate

LBF	neutral twill	+\$0
LBG	sarum twill	+\$0
LBH	earthen twill	+\$0
LBJ	graphite twill	+\$0
LBQ	white twill	+\$0

Wood-Grain Laminate

HM	natural maple	+\$0
HP	light anigre	+\$0
LA	light ash	+\$0
LBA	clear on ash	+\$0
LBB	oak on ash	+\$0
LBC	walnut on ash	+\$0
LBD	dark brown walnut	+\$0
LBR	phantom ecru	+\$0
LBS	phantom cocoa	+\$0
LBU	medium matte walnut	+\$0
LBV	warm grey teak	+\$0
LBE	medium red walnut	+\$0
LM	mahogany	+\$0
76	light brown walnut	+\$0
HX	aged cherry	+\$0
HY	walnut on cherry	+\$0

Zephyr Laminate

28	canyon	+\$0
29	misted	+\$0

Step 11. Edge Finish

For 1¹/₄"-high laminate top with thermoplastic edge (TL)

28	canyon	+\$0
29	misted	+\$0
76	light brown walnut	+\$0
8Q	folkstone grey	+\$0
91	white	+\$0
98	studio white	+\$0
BU	black umber	+\$0

Arc-Pull Freestanding Lateral File

continued

Meridian® Freestanding Stackable™ Lateral Files

CL	cool grey neutral	+\$0
G2	graphite satin	+\$0
HF	inner tone light	+\$0
HM	natural maple	+\$0
HP	light anigre	+\$0
HT	inner tone	+\$0
HX	aged cherry	+\$0
HY	walnut on cherry	+\$0
LA	light ash	+\$0
LBA	clear on ash	+\$0
LBB	oak on ash	+\$0
LBC	walnut on ash	+\$0
LBD	dark brown walnut	+\$0
LBR	phantom ecru	+\$0
LBS	phantom cocoa	+\$0
LBU	medium matte walnut	+\$0
LBV	warm grey teak	+\$0
LBE	medium red walnut	+\$0
LBK	pewter mesh	+\$0
LBL	steel mesh	+\$0
LBM	crisp linen	+\$0
LBN	classic linen	+\$0
LBP	casual linen	+\$0
LBF	neutral twill	+\$0
LBG	sarum twill	+\$0
LBH	earthen twill	+\$0
LBJ	graphite twill	+\$0
LBQ	white twill	+\$0
LM	mahogany	+\$0
LU	soft white	+\$0
MT	medium tone	+\$0
SG	slate grey	+\$0
WA	wheat	+\$0
WL	sandstone	+\$0
WN	warm grey neutral	+\$0

Step 12. Cushion Top Fabric

For 1" cushion top (TC1) or 2" cushion top (TC2)

See textiles list for fabric numbers. First 2 digits of number indicate fabric line; remaining digit(s) indicate fabric color.

Price Category 1	+\$0
Price Category 2	+\$68
Price Category 3	+\$82
Price Category 4	+\$101
Price Category 7 A	+\$137
Price Category 9	+\$950
Price Category B	+\$47
Price Category C	+\$65
Price Category E	+\$99
Price Category G	+\$166
Price Category H	+\$204

Step 13. Lock

For no top (NT), 1¹/₄"-high laminate top with thermoplastic edge (TL), 6¹/₂"-high planter top (T7), 6¹/₂"-high full dome, side-to-side (D1), 6¹/₂"-high half dome, sloping left (H1), 6¹/₂"-high half dome, sloping right (H2), or 1¹/₈"-high wood veneer top and wood composite edge with oversail front (TV1)

NL no lock	-\$30
-------------------	-------

For 1"-high painted metal top with squared edge (T1), 1¹/₄"-high painted metal top with squared edge (T2), 1¹/₄"-high painted metal top with radius edge (T3), 1¹/₄"-high recut veneer top (TR), 1¹/₄"-high wood veneer top (TF), 1" cushion top (TC1), or 2" cushion top (TC2)

KA keyed alike	+\$0
KC keyed differently, chrome	+\$0
KD keyed differently, black	+\$0

Step 14. Pull Finish

NH brushed nickel	+\$0
NK black nickel	+\$0

Arc-Pull Freestanding Lateral File

continued

Step 15. Base Height		
B1	1"-high base	+\$0
B2	1½"-high base	+\$0
B3	2¼"-high base	+\$0
B4	3¼"-high base	+\$0
BA	1"-high recessed base	+\$33
BB	1½"-high recessed base	+\$33
BC	2¼"-high recessed base	+\$33
BD	3¼"-high recessed base	+\$33
B5	4¼"-high base	+\$33
LB2	1½" leg base	+\$33

Step 16. Leg		
<i>For 1½" leg base (LB2)</i>		
DD	2"-high canvas leg	+\$122

Step 17. Leg Finish		
91	white	+\$0
CL	cool grey neutral	+\$0
G1	graphite	+\$0
WN	warm grey neutral	+\$0

Metallic Paint		
CN	metallic champagne	+\$10
EH	metallic bronze	+\$10
MS	metallic silver	+\$10

Step 18. Counterweight		
NO	no counterweight (must gang or anchor)	+\$0
CB	counterweight (recommended)	+\$119

Step 19. Drawer Interior		
9P	front-to-back filing rail	+\$0
9R	side-to-side filing rail	+\$0
9M	3 dividers	+\$0

Bar-Pull Freestanding Lateral File

2KP-3
2KP-4
2KV-3
2KV-4

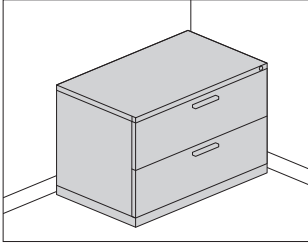

Product Information

Description

This lateral file holds letter-, legal-, and A4-size hanging files. It has bar pulls and smooth or textured steel. The file has no top or a metal, cushion, laminate, planter, or veneer top. A positive interlock system permits only 1 drawer to open at a time. 1 lock controls all drawers. The drawers can be specified with 3 dividers or with front-to-back or side-to-side filing rails for hanging files. 5 base heights are available; all bases include adjustable glides.

Actual lateral file widths are $29\frac{7}{8}$ " , $35\frac{7}{8}$ " , or $41\frac{7}{8}$ " ; actual depths are $17\frac{7}{8}$ " or $19\frac{7}{8}$ " .

Notes

For 2- or 3-high files that are not ganged or anchored, counterweights (option CB) are required. For 4- or 5-high files that are not ganged or anchored, counterweights are recommended.

For base height option (LB2), legs will be shipped separately.

For base height option (LB2), overall height is $3\frac{1}{2}$ " consisting of $1\frac{1}{2}$ " tube base with 2" legs.

Dimensional illustrations do not include all possible configurations.

To convert filing direction, order 1 of the following products separately:

- Front-to-back rail (gPxxxx)
- Side-to-side rail (gRxxxx)

See Stackable Lateral File Accessories for specific product number.

Order optional file drawer organizer (LG901) separately.

For work surface on top of 1 or more lateral files, order file top (TPL or TPV) separately.

No lock option (NL) can only be specified on files with no top (NT), dome tops (D1, H1, or H2), planter top (T7), laminate tops (TL), or veneer top (TV1).

For cushion tops TC1 and TC2, a 1" metal top is included.

Grain direction is vertical for veneer-front lateral files.

Cushion top accepts Customer's Own Material (COM). Yardage is estimated for nondirectional, 54"-wide fabrics. When ordering more than 1 cushion, round up total yardage requirement to next whole yard of fabric.

Width—Yardage

30" — 1.05

36" — 1.22

42" — 1.40

For information on multiple quantities or directional fabrics, contact COM Department. See Order Information in Appendices.

For keyed-alike locks, order lock plugs separately. See Keyed-Alike Information in Appendices.

Dimensions

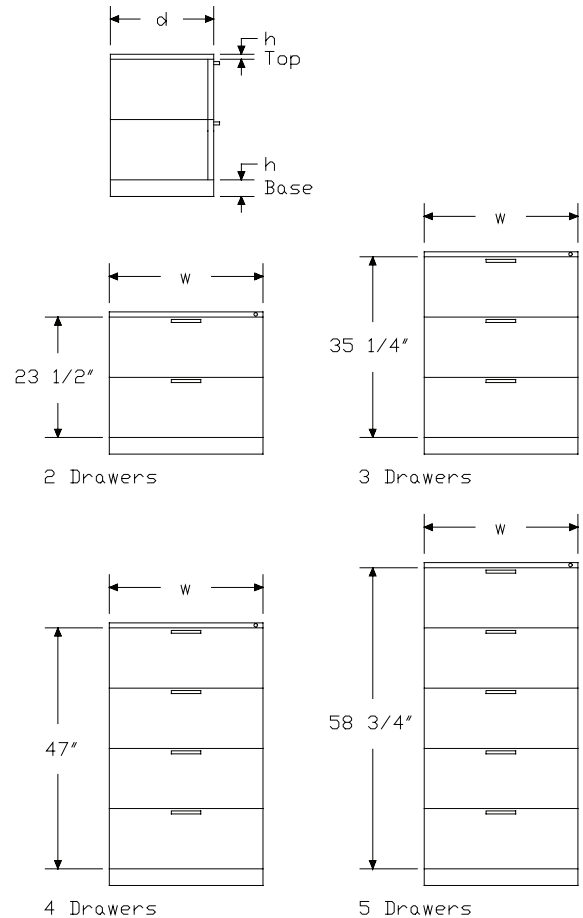

Bar-Pull Freestanding Lateral File

continued

Specification Information

Step 1.

2K

Step 2. Front Material

P- painted metal front
V- veneer front

Step 3. Width

30 30" wide
36 36" wide
42 42" wide

Step 4. Depth

18- 18" deep
20- 20" deep

Step 5. Configuration

2N 2 drawers
3N 3 drawers
4N 4 drawers
5N 5 drawers

Prices for Steps 1-5.

	2N	3N	4N	5N
2KP-30 18-	\$842	1156	1471	1785
20-	\$842	1156	1471	1785
2KP-36 18-	\$931	1274	1618	1961
20-	\$931	1274	1618	1961
2KP-42 18-	\$1049	1435	1823	2212
20-	\$1049	1435	1823	2212
2KV-30 18-	\$1170	1650	2237	2607
20-	\$1170	1650	2237	2607
2KV-36 18-	\$1324	1865	2406	2946
20-	\$1324	1865	2406	2946
2KV-42 18-	\$1504	2119	2737	3351
20-	\$1504	2119	2737	3351

Step 6. Paint/Steel Type

SS smooth paint on smooth steel +\$0
TS smooth paint on textured steel +\$35
XS textured paint on smooth steel +\$0

Step 7. Surface Finish

Nonmetallic Paint

For smooth paint on smooth steel (SS) or smooth paint on textured steel (TS)

8Q	folkstone grey	+\$0
91	white	+\$0
98	studio white A	+\$0
9J	sparrow	+\$0
BU	black umber	+\$0
G2	graphite satin	+\$0
HF	inner tone light	+\$0
HT	inner tone	+\$0
LT	light tone	+\$0
LU	soft white	+\$0
MT	medium tone	+\$0
SG	slate grey	+\$0
WA	wheat	+\$0
WL	sandstone	+\$0

Metallic Paint

For smooth paint on smooth steel (SS) or smooth paint on textured steel (TS)

1209	platinum	+\$65
1210	hematite	+\$65
1212	bronzite	+\$65
CN	metallic champagne	+\$65
EH	metallic bronze	+\$65
MS	metallic silver	+\$65

Sand Texture Paint

For textured paint on smooth steel (XS)

98	studio white A	+\$0
-----------	--	------

Bright Sand Texture Paint

For textured paint on smooth steel (XS)

91	white	+\$0
CL	cool grey neutral	+\$0
G1	graphite	+\$0
WN	warm grey neutral	+\$0

Bar-Pull Freestanding Lateral File

continued

Meridian® Freestanding Stackable™ Lateral Files

Step 8. Top

For painted metal front (P-)

NT	no top	+\$0
T1	1"-high painted metal top with squared edge	+\$0
T2	1¼"-high painted metal top with squared edge	+\$0
T3	1¼"-high painted metal top with radius edge	+\$63
TL	1¼"-high laminate top with thermoplastic edge	+\$72
TR	1¼"-high recut veneer top A	+\$147
TF	1¼"-high wood veneer top A	+\$152
T7	6½"-high planter top	+\$196
D1	6½"-high full dome, side-to-side	+\$267
H1	6½"-high half dome, sloping left	+\$267
H2	6½"-high half dome, sloping right	+\$267
TV1	1⅛"-high wood veneer top and wood composite edge with oversail front A	+\$314
TC1	1" cushion top	+\$386
TC2	2" cushion top	+\$386

For veneer front (V-)

NT	no top	+\$0
T1	1"-high painted metal top with squared edge	+\$0
T2	1¼"-high painted metal top with squared edge	+\$0
T3	1¼"-high painted metal top with radius edge	+\$63
TL	1¼"-high laminate top with thermoplastic edge	+\$72
TF	1¼"-high wood veneer top A	+\$152
T7	6½"-high planter top	+\$196
D1	6½"-high full dome, side-to-side	+\$267
H1	6½"-high half dome, sloping left	+\$267
H2	6½"-high half dome, sloping right	+\$267
TV1	1⅛"-high wood veneer top and wood composite edge with oversail front A	+\$314
TC1	1" cushion top	+\$386
TC2	2" cushion top	+\$386

Step 9.

Veneer Top Finish: Wood Veneer

For painted metal front (P-) with 1¼"-high wood veneer top (TF)

2U	light brown walnut A	+\$28
40	dark brown walnut A	+\$28
ED	aged cherry A	+\$28
EK	medium red walnut A	+\$28
EW	medium matte walnut A	+\$28
ET	clear on ash A	+\$28
EV	walnut on ash A	+\$28
UL	natural maple A	+\$28
UX	walnut on cherry A	+\$28

Veneer Front Finish: Wood Veneer

For veneer front (V-) with no top (NT), 1"-high painted metal top with squared edge (T1), 1¼"-high painted metal top with squared edge (T2), 1¼"-high painted metal top with radius edge (T3), 1¼"-high laminate top with thermoplastic edge (TL), 6½"-high planter top (T7), 6½"-high full dome, side-to-side (D1), 6½"-high half dome, sloping left (H1), 6½"-high half dome, sloping right (H2), or 1" cushion top (TC1), or 2" cushion top (TC2)

2U	light brown walnut A	+\$56
40	dark brown walnut A	+\$56
ED	aged cherry A	+\$56
EK	medium red walnut A	+\$56
EW	medium matte walnut A	+\$56
ET	clear on ash A	+\$56
EV	walnut on ash A	+\$56
UL	natural maple A	+\$56
UX	walnut on cherry A	+\$56

Veneer Top Finish: Wood Veneer

For painted metal front (P-) with 1⅛"-high wood veneer top and wood composite edge with oversail front (TV1)

40	dark brown walnut A	+\$28
ED	aged cherry A	+\$28
EK	medium red walnut A	+\$28
EW	medium matte walnut A	+\$28
ET	clear on ash A	+\$28
EV	walnut on ash A	+\$28
UL	natural maple A	+\$28
UX	walnut on cherry A	+\$28

Bar-Pull Freestanding Lateral File

continued

Veneer Front/Top Finish: Wood Veneer		
<i>For veneer front (V-) with 1 1/8"-high wood veneer top and wood composite edge with oversail front (TV1)</i>		
40	dark brown walnut <input type="checkbox"/>	+\$56
ED	aged cherry <input type="checkbox"/>	+\$56
EK	medium red walnut <input type="checkbox"/>	+\$56
EW	medium matte walnut <input type="checkbox"/>	+\$56
ET	clear on ash <input type="checkbox"/>	+\$56
EV	walnut on ash <input type="checkbox"/>	+\$56
UL	natural maple <input type="checkbox"/>	+\$56
UX	walnut on cherry <input type="checkbox"/>	+\$56

Veneer Top Finish: Recut Veneer		
<i>For painted metal front (P-) with 1 1/4"-high recut veneer top (TR)</i>		
RA	light ash <input type="checkbox"/>	+\$0
RK	mahogany dark <input type="checkbox"/>	+\$0
RM	mahogany <input type="checkbox"/>	+\$0

Veneer Front/Top Finish: Wood Veneer		
<i>For veneer front (V-) with 1 1/4"-high wood veneer top (TF)</i>		
2U	light brown walnut <input type="checkbox"/>	+\$56
40	dark brown walnut <input type="checkbox"/>	+\$56
ED	aged cherry <input type="checkbox"/>	+\$56
EK	medium red walnut <input type="checkbox"/>	+\$56
EW	medium matte walnut <input type="checkbox"/>	+\$56
ET	clear on ash <input type="checkbox"/>	+\$56
EV	walnut on ash <input type="checkbox"/>	+\$56
UL	natural maple <input type="checkbox"/>	+\$56
UX	walnut on cherry <input type="checkbox"/>	+\$56

Step 10. Top Finish
For 1 1/4"-high laminate top with thermoplastic edge (TL)

Solid-Color Laminate		
8Q	folkstone grey	+\$0
91	white	+\$0
98	studio white	+\$0
CL	cool grey neutral	+\$0
HF	inner tone light	+\$0
HT	inner tone	+\$0
LT	light tone	+\$0
LU	soft white	+\$0
WL	sandstone	+\$0
WN	warm grey neutral	+\$0

Linen Laminate		
LBM	crisp linen	+\$0
LBN	classic linen	+\$0
LBP	casual linen	+\$0

Mesh Laminate		
LBK	pewter mesh	+\$0
LBL	steel mesh	+\$0

Twill Laminate		
LBF	neutral twill	+\$0
LBG	sarum twill	+\$0
LBH	earthen twill	+\$0
LBJ	graphite twill	+\$0
LBQ	white twill	+\$0

Wood-Grain Laminate		
HM	natural maple	+\$0
HP	light anigre	+\$0
LA	light ash	+\$0
LBA	clear on ash	+\$0
LBB	oak on ash	+\$0
LBC	walnut on ash	+\$0
LBD	dark brown walnut	+\$0
LBR	phantom ecru	+\$0
LBS	phantom cocoa	+\$0
LBU	medium matte walnut	+\$0
LBV	warm grey teak	+\$0
LBE	medium red walnut	+\$0
LM	mahogany	+\$0
76	light brown walnut	+\$0
HX	aged cherry	+\$0
HY	walnut on cherry	+\$0

Zephyr Laminate		
28	canyon	+\$0
29	misted	+\$0

Step 11. Edge Finish
For 1 1/4"-high laminate top with thermoplastic edge (TL)

28	canyon	+\$0
29	misted	+\$0
76	light brown walnut	+\$0
8Q	folkstone grey	+\$0
91	white	+\$0
BU	black umber	+\$0
CL	cool grey neutral	+\$0

Meridian® Freestanding Stackable™ Lateral Files

Bar-Pull Freestanding Lateral File

continued

Meridian® Freestanding Stackable™ Lateral Files

G2	graphite satin	+\$0
HF	inner tone light	+\$0
HM	natural maple	+\$0
HP	light anigre	+\$0
HT	inner tone	+\$0
HX	aged cherry	+\$0
HY	walnut on cherry	+\$0
LA	light ash	+\$0
LBA	clear on ash	+\$0
LBB	oak on ash	+\$0
LBC	walnut on ash	+\$0
LBD	dark brown walnut	+\$0
LBR	phantom ecru	+\$0
LBS	phantom cocoa	+\$0
LBU	medium matte walnut	+\$0
LBV	warm grey teak	+\$0
LBE	medium red walnut	+\$0
LBK	pewter mesh	+\$0
LBL	steel mesh	+\$0
LBM	crisp linen	+\$0
LBN	classic linen	+\$0
LBP	casual linen	+\$0
LBF	neutral twill	+\$0
LBG	sarum twill	+\$0
LBH	earthen twill	+\$0
LBJ	graphite twill	+\$0
LBQ	white twill	+\$0
LM	mahogany	+\$0
LU	soft white	+\$0
MT	medium tone	+\$0
SG	slate grey	+\$0
WA	wheat	+\$0
WL	sandstone	+\$0
WN	warm grey neutral	+\$0

Step 12. Cushion Top Fabric

For 1" cushion top (TC1) or 2" cushion top (TC2)

See textiles list for fabric usage and numbers. First 2 digits of number indicate fabric line; remaining digit(s) indicate fabric color.

Price Category 1	+\$0
Price Category 2	+\$68
Price Category 3	+\$82
Price Category 4	+\$101
Price Category 7 A	+\$0
Price Category 9	+\$950
Price Category B	+\$43
Price Category G	+\$151
Price Category H	+\$185

Step 13. Lock

For no top (NT), 1¹/₄"-high laminate top with thermoplastic edge (TL), 6¹/₂"-high planter top (T7), 6¹/₂"-high full dome, side-to-side (D1), 6¹/₂"-high half dome, sloping left (H1), 6¹/₂"-high half dome, sloping right (H2), or 1¹/₈"-high wood veneer top and wood composite edge with oversail front (TV1)

NL	no lock	-\$30
-----------	---------	-------

For 1"-high painted metal top with squared edge (T1), 1¹/₄"-high painted metal top with squared edge (T2), 1¹/₄"-high painted metal top with radius edge (T3), 1¹/₄"-high recut veneer top (TR), 1¹/₄"-high wood veneer top (TF), 1" cushion top (TC1), or 2" cushion top (TC2)

KA	keyed alike	+\$0
KC	keyed differently, chrome	+\$0
KD	keyed differently, black	+\$0

Step 14. Pull Finish

8Q	folkstone grey	+\$0
91	white	+\$0
98	studio white	+\$0
MS	metallic silver	+\$0

Bar-Pull Freestanding Lateral File

continued

Step 15. Base Height		
B1	1"-high base	+\$0
B2	1½"-high base	+\$0
B3	2¼"-high base	+\$0
B4	3¼"-high base	+\$0
BA	1"-high recessed base	+\$33
BB	1½"-high recessed base	+\$33
BC	2¼"-high recessed base	+\$33
BD	3¼"-high recessed base	+\$33
B5	4¼"-high base	+\$33
LB2	1½" leg base	+\$33

Step 16. Leg		
<i>For 1½" leg base (LB2)</i>		
DD	2"-high canvas leg	+\$122

Step 17. Leg Finish		
91	white	+\$0
98	studio white	+\$0
CL	cool grey neutral	+\$0
G1	graphite	+\$0
WN	warm grey neutral	+\$0

Metallic Paint		
CN	metallic champagne	+\$10
EH	metallic bronze	+\$10
MS	metallic silver	+\$10

Step 18. Counterweight		
NO	no counterweight (must gang or anchor)	+\$0
CB	counterweight (recommended)	+\$119

Step 19. Drawer Interior		
9P	front-to-back filing rail	+\$0
9R	side-to-side filing rail	+\$0
9M	3 dividers	+\$0

Bevel-Pull Freestanding Lateral File 24-30
 24-36
 24-42

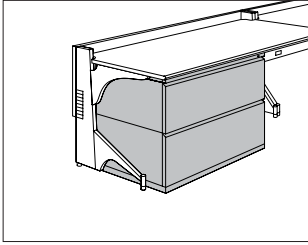

Product Information

Description

This lateral file holds letter-, legal-, and A4-size hanging files. It has bevel pulls and smooth or textured steel. The file has no top or a metal, cushion, laminate, planter, or veneer top. A positive interlock system permits only 1 drawer to open at a time. 1 lock controls all drawers. The drawers can be specified with 3 dividers or with front-to-back or side-to-side filing rails for hanging files. 5 base heights are available; all bases include adjustable glides.

Actual lateral file widths are 29⁷/₈" , 35⁷/₈" , or 41⁷/₈" ; actual depths are 17⁷/₈" or 19⁷/₈" .

Notes

For 2- or 3-high files that are not ganged or anchored, counterweights (option CB) are required. For 4- or 5-high files that are not ganged or anchored, counterweights are recommended.

Dimensional illustrations do not include all possible configurations.

To convert filing direction, order 1 of the following products separately:

- Front-to-back rail (gPxxxx)
- Side-to-side rail (gRxxxx)

See Stackable Lateral File Accessories for specific product number.

Order optional file drawer organizer (LG901) separately.

For work surface on top of 1 or more lateral files, order file top (TPL or TPV) separately.

No lock option (NL) can only be specified on files with no top (NT), dome tops (D1, H1, or H2), planter top (T7), laminate tops (TL), or veneer top (TV1).

For cushion tops TC1 and TC2, a 1" metal top is included.

Cushion top accepts Customer's Own Material (COM). Yardage is estimated for nondirectional, 54"-wide fabrics. When ordering more than 1 cushion, round up total yardage requirement to next whole yard of fabric.

Width—Yardage

30" —1.05

36" —1.22

42" —1.40

For information on multiple quantities or directional fabrics, contact COM Department. See Order Information in Appendices.

For keyed-alike locks, order lock plugs separately. See Keyed-Alike Information in Appendices.

Dimensions

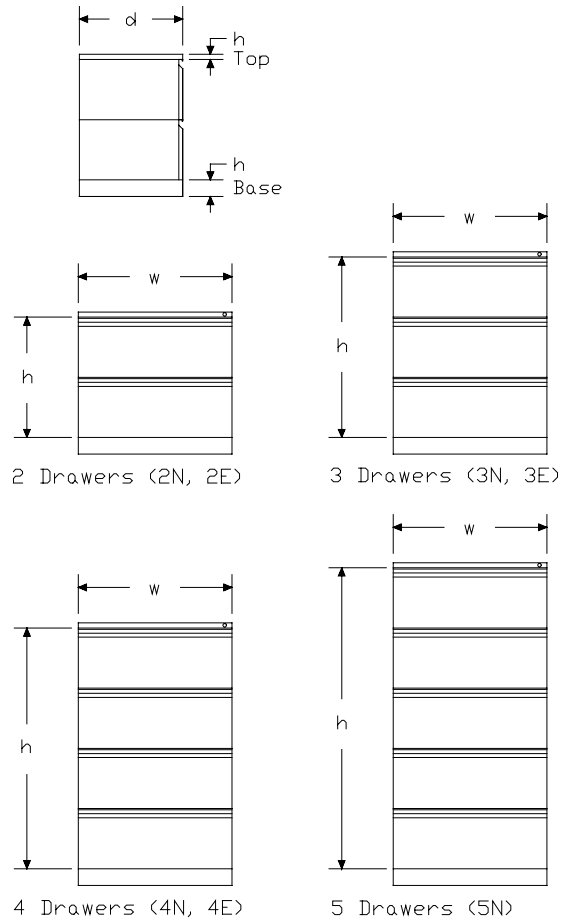

h	N	E
2	23 1/2	26 1/4
3	35 1/4	39 3/8
4	47	52 1/2
5	58 3/4	-

All dimensions are in inches.

Bevel-Pull Freestanding Lateral File *continued*

Specification Information

Step 1.

24-

Step 2. Width

30	30" wide
36	36" wide
42	42" wide

Step 3. Depth

18-	18" deep
20-	20" deep

Step 4. Configuration

2N	2 11 ³ / ₄ "-high drawers
3N	3 11 ³ / ₄ "-high drawers
4N	4 11 ³ / ₄ "-high drawers
5N	5 11 ³ / ₄ "-high drawers
2E	2 13 ¹ / ₈ "-high drawers
3E	3 13 ¹ / ₈ "-high drawers
4E	4 13 ¹ / ₈ "-high drawers

Prices for Steps 1-4.

		2N	3N	4N	5N	2E	3E	
24-30	18-	\$802	1115	1430	1744	802	1115	
	20-	\$802	1115	1430	1744	802	1115	
24-36	18-	\$889	1232	1576	1919	889	1232	
	20-	\$889	1232	1576	1919	889	1232	
24-42	18-	\$1008	1394	1781	2170	1008	1394	
	20-	\$1008	1394	1781	2170	1008	1394	
								4E
24-30	18-							\$1430
	20-							\$1430
24-36	18-							\$1576
	20-							\$1576
24-42	18-							\$1781
	20-							\$1781

Step 5. Paint/Steel Type

SS	smooth paint on smooth steel	+\$0
TS	smooth paint on textured steel	+\$35
XS	textured paint on smooth steel	+\$0

Step 6. Surface Finish

Nonmetallic Paint

For smooth paint on smooth steel (SS) or smooth paint on textured steel (TS)

8Q	folkstone grey	+\$0
91	white	+\$0
98	studio white A	+\$0
9J	sparrow	+\$0
BU	black umber	+\$0
G2	graphite satin	+\$0
HF	inner tone light	+\$0
HT	inner tone	+\$0
LT	light tone	+\$0
LU	soft white	+\$0
MT	medium tone	+\$0
SG	slate grey	+\$0
WA	wheat	+\$0
WL	sandstone	+\$0

Metallic Paint

For smooth paint on smooth steel (SS) or smooth paint on textured steel (TS)

1209	platinum	+\$65
1210	hematite	+\$65
1212	bronzite	+\$65
CN	metallic champagne	+\$65
MS	metallic silver	+\$65

Sand Texture Paint

For textured paint on smooth steel (XS)

98	studio white	+\$0
-----------	--------------	------

Bright Sand Texture Paint

For textured paint on smooth steel (XS)

91	white	+\$0
CL	cool grey neutral	+\$0
G1	graphite	+\$0
WN	warm grey neutral	+\$0

Bevel-Pull Freestanding Lateral

File *continued*

Step 7. Top		
NT	no top	+\$0
T1	1"-high painted metal top with squared edge	+\$0
T2	1 1/4"-high painted metal top with squared edge	+\$0
T3	1 1/4"-high painted metal top with radius edge	+\$63
TL	1 1/4"-high laminate top with thermoplastic edge	+\$72
TR	1 1/4"-high recut veneer top <input type="checkbox"/> A	+\$147
TF	1 1/4"-high wood veneer top <input type="checkbox"/> A	+\$152
T7	6 1/2"-high planter top	+\$196
D1	6 1/2"-high full dome, side-to-side	+\$267
H1	6 1/2"-high half dome, sloping left	+\$267
H2	6 1/2"-high half dome, sloping right	+\$267
TV1	1 1/8"-high wood veneer top and wood composite edge with oversail front <input type="checkbox"/> A	+\$314
TC1	1" cushion top	+\$386
TC2	2" cushion top	+\$386

Step 8. Lock		
<i>For no top (NT), 1 1/4"-high laminate top with thermoplastic edge (TL), 6 1/2"-high planter top (T7), 6 1/2"-high full dome, side-to-side (D1), 6 1/2"-high half dome, sloping left (H1), 6 1/2"-high half dome, sloping right (H2), or 1 1/8"-high wood veneer top and wood composite edge with oversail front (TV1)</i>		
NL	no lock	-\$30

<i>For 1"-high painted metal top with squared edge (T1), 1 1/4"-high painted metal top with squared edge (T2), 1 1/4"-high painted metal top with radius edge (T3), 1 1/4"-high recut veneer top (TR), 1 1/4"-high wood veneer top (TF), 1" cushion top (TC1), or 2" cushion top (TC2)</i>		
KA	keyed alike	+\$0
KC	keyed differently, chrome	+\$0
KD	keyed differently, black	+\$0

Step 9.		
Veneer Top Finish: Wood Veneer		
<i>For 1 1/4"-high wood veneer top (TF)</i>		
2U	light brown walnut <input type="checkbox"/> A	+\$28
40	dark brown walnut <input type="checkbox"/> A	+\$28
ED	aged cherry <input type="checkbox"/> A	+\$28
EK	medium red walnut <input type="checkbox"/> A	+\$28
EW	medium matte walnut <input type="checkbox"/> A	+\$28
ET	clear on ash <input type="checkbox"/> A	+\$28
EU	oak on ash <input type="checkbox"/> A	+\$28
EV	walnut on ash <input type="checkbox"/> A	+\$28
UL	natural maple <input type="checkbox"/> A	+\$28
UX	walnut on cherry <input type="checkbox"/> A	+\$28

Veneer Top Finish: Wood Veneer		
<i>For 1 1/8"-high wood veneer top and wood composite edge with oversail front (TV1)</i>		
40	dark brown walnut <input type="checkbox"/> A	+\$28
ED	aged cherry <input type="checkbox"/> A	+\$28
EK	medium red walnut <input type="checkbox"/> A	+\$28
EW	medium matte walnut <input type="checkbox"/> A	+\$28
ET	clear on ash <input type="checkbox"/> A	+\$28
EU	oak on ash <input type="checkbox"/> A	+\$28
EV	walnut on ash <input type="checkbox"/> A	+\$28
UL	natural maple <input type="checkbox"/> A	+\$28
UX	walnut on cherry <input type="checkbox"/> A	+\$28

Veneer Top Finish: Recut Veneer		
<i>For 1 1/4"-high recut veneer top (TR)</i>		
RA	light ash <input type="checkbox"/> A	+\$0
RK	mahogany dark <input type="checkbox"/> A	+\$0
RM	mahogany <input type="checkbox"/> A	+\$0

Top Finish: Solid-Color Laminate		
<i>For 1 1/4"-high laminate top with thermoplastic edge (TL)</i>		
8Q	folkstone grey	+\$0
91	white	+\$0
98	studio white	+\$0
CL	cool grey neutral	+\$0
HF	inner tone light	+\$0
HT	inner tone	+\$0
LT	light tone	+\$0
LU	soft white	+\$0
WL	sandstone	+\$0
WN	warm grey neutral	+\$0

Bevel-Pull Freestanding Lateral File *continued*

Top Finish: Linen Laminate

For 1 1/4"-high laminate top with thermoplastic edge (TL)

LBM	crisp linen	+\$0
LBN	classic linen	+\$0
LBP	casual linen	+\$0

Top Finish: Mesh Laminate

For 1 1/4"-high laminate top with thermoplastic edge (TL)

LBK	pewter mesh	+\$0
LBL	steel mesh	+\$0

Top Finish: Twill Laminate

For 1 1/4"-high laminate top with thermoplastic edge (TL)

LBF	neutral twill	+\$0
LBG	sarum twill	+\$0
LBH	earthen twill	+\$0
LBJ	graphite twill	+\$0
LBQ	white twill	+\$0

Top Finish: Wood-Grain Laminate

For 1 1/4"-high laminate top with thermoplastic edge (TL)

HM	natural maple	+\$0
HP	light anigre	+\$0
LA	light ash	+\$0
LBA	clear on ash	+\$0
LBB	oak on ash	+\$0
LBC	walnut on ash	+\$0
LBD	dark brown walnut	+\$0
LBR	phantom ecru	+\$0
LBS	phantom cocoa	+\$0
LBU	medium matte walnut	+\$0
LBV	warm grey teak	+\$0
LBE	medium red walnut	+\$0
LM	mahogany	+\$0
76	light brown walnut	+\$0
HX	aged cherry	+\$0
HY	walnut on cherry	+\$0

Top Finish: Zephyr Laminate

For 1 1/4"-high laminate top with thermoplastic edge (TL)

28	canyon	+\$0
29	misted	+\$0

Step 10. Edge Finish

For 1 1/4"-high laminate top with thermoplastic edge (TL)

28	canyon	+\$0
29	misted	+\$0
76	light brown walnut	+\$0
8Q	folkstone grey	+\$0
91	white	+\$0
BU	black umber	+\$0
CL	cool grey neutral	+\$0
G2	graphite satin	+\$0
HF	inner tone light	+\$0
HM	natural maple	+\$0
HP	light anigre	+\$0
HT	inner tone	+\$0
HX	aged cherry	+\$0
HY	walnut on cherry	+\$0
LA	light ash	+\$0
LBA	clear on ash	+\$0
LBB	oak on ash	+\$0
LBC	walnut on ash	+\$0
LBD	dark brown walnut	+\$0
LBR	phantom ecru	+\$0
LBS	phantom cocoa	+\$0
LBU	medium matte walnut	+\$0
LBV	warm grey teak	+\$0
LBE	medium red walnut	+\$0
LM	mahogany	+\$0
LU	soft white	+\$0
MT	medium tone	+\$0
SG	slate grey	+\$0
WA	wheat	+\$0
WL	sandstone	+\$0
WN	warm grey neutral	+\$0

Step 11. Cushion Top Fabric

For 1" cushion top (TC1) or 2" cushion top (TC2)

See textiles list for fabric numbers. First 2 digits of number indicate fabric line; remaining digit(s) indicate fabric color.

Price Category 1	+\$0
Price Category 2	+\$68
Price Category 3	+\$82
Price Category 4	+\$101
Price Category 9	+\$950
Price Category B	+\$47
Price Category E	+\$99
Price Category G	+\$166
Price Category H	+\$204

Bevel-Pull Freestanding Lateral

File *continued*

Meridian® Freestanding Stackable™ Lateral Files

Step 12. Base Height		
B1	1"-high base	+\$0
B2	1½"-high base	+\$0
B3	2¼"-high base	+\$0
B4	3¼"-high base	+\$0
BA	1"-high recessed base	+\$33
BB	1½"-high recessed base	+\$33
BC	2¼"-high recessed base	+\$33
BD	3¼"-high recessed base	+\$33
B5	4¼"-high base	+\$33

Step 13. Counterweight		
NO	no counterweight (must gang or anchor)	+\$0
CB	counterweight (recommended)	+\$119

Step 14. Drawer Interior		
9P	front-to-back filing rail	+\$0
9R	side-to-side filing rail	+\$0
9M	3 dividers	+\$0

Ellipse-Pull Freestanding Lateral File

2J-30
2J-36
2J-42

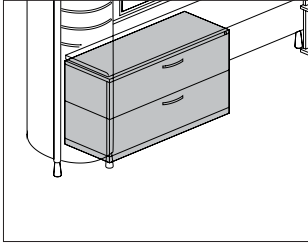

Product Information

Description

This lateral file holds letter-, legal-, and A4-size hanging files. It has ellipse pulls and smooth steel. The file has no top or a metal, cushion, laminate, planter, or veneer top. A positive interlock system permits only 1 drawer to open at a time. 1 lock controls all drawers. The drawers can be specified with 3 dividers or with front-to-back or side-to-side filing rails for hanging files. 5 base heights are available; all bases include adjustable glides.

Actual lateral file widths are 29⁷/₈" , 35⁷/₈" , or 41⁷/₈" ; actual depths are 17⁷/₈" or 19⁷/₈" .

Notes

For 2- or 3-high files that are not ganged or anchored, counterweights (option CB) are required. For 4- or 5-high files that are not ganged or anchored, counterweights are recommended.

Dimensional illustrations do not include all possible configurations.

To convert filing direction, order 1 of the following products separately:

- Front-to-back rail (9Pxxxx)
- Side-to-side rail (9Rxxxx)

See Stackable Lateral File Accessories for specific product number.

Order optional file drawer organizer (LG901) separately.

For work surface on top of 1 or more lateral files, order file top (TPL or TPV) separately.

No lock option (NL) can only be specified on files with no top (NT), dome tops (D1, H1, or H2), planter top (T7), or laminate tops (TL). The (NL) option cannot be specified for configurations 4W and 4Z; these configurations always have a lock.

For configurations 4W and 4Z, a 1" filler top is included between the overhead storage and the drawers.

For cushion tops TC1 and TC2, a 1" metal top is included.

Cushion top accepts Customer's Own Material (COM). Yardage is estimated for nondirectional, 54"-wide fabrics. When ordering more than 1 cushion, round up total yardage requirement to next whole yard of fabric.

Width—Yardage

30" —1.05

36" —1.22

42" —1.40

For information on multiple quantities or directional fabrics, contact COM Department. See Order Information in Appendices.

For keyed-alike locks, order lock plugs separately. See Keyed-Alike Information in Appendices.

Dimensions

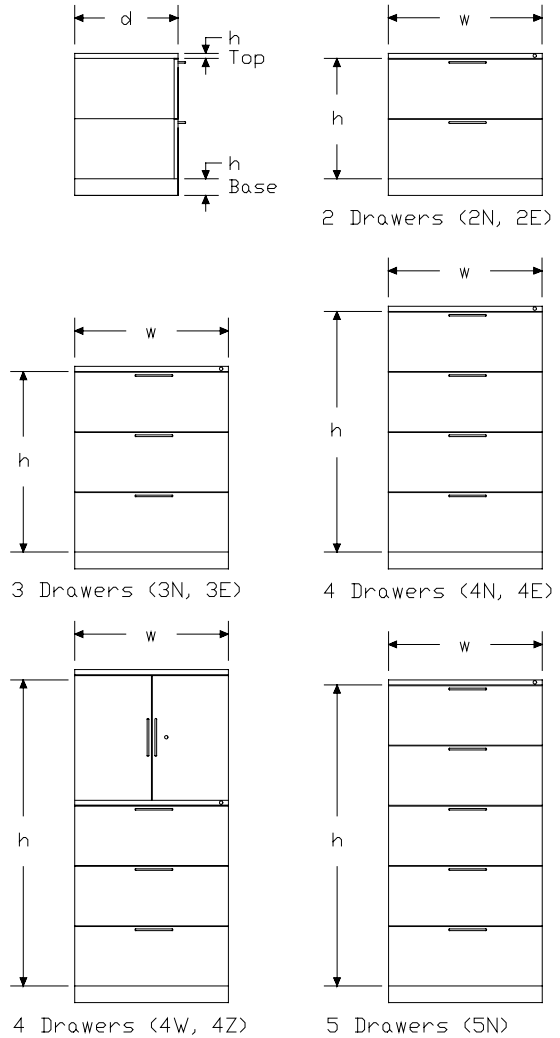

h	N	E	W	Z
2	23 1/2	26 1/4	-	-
3	35 1/4	39 3/8	-	-
4	47	52 1/2	62 1/2	66 5/8
5	58 3/4	-	-	-

All dimensions are in inches.

Ellipse-Pull Freestanding Lateral

File *continued*

Specification Information

Step 1.

2J- A

Step 2. Width

30 30" wide A

36 36" wide A

42 42" wide A

Step 3. Depth

18- 18" deep A

20- 20" deep A

Step 4. Configuration

2N 2 11³/₄"-high drawers A

3N 3 11³/₄"-high drawers A

4N 4 11³/₄"-high drawers A

4W 1 26¹/₄"-high overhead storage, 3 11³/₄"-high drawers A

5N 5 11³/₄"-high drawers A

2E 2 13¹/₈"-high drawers A

3E 3 13¹/₈"-high drawers A

4E 4 13¹/₈"-high drawers A

4Z 1 26¹/₄"-high overhead storage, 3 13¹/₈"-high drawers A

Prices for Steps 1-4.

		2N	3N	4N	4W	5N	2E	
2J-30	18-	\$878	1227	1573	1941	1918	878	
	20-	\$878	1227	1573	1941	1918	878	
2J-36	18-	\$978	1355	1733	2166	2111	978	
	20-	\$978	1355	1733	2166	2111	978	
2J-42	18-	\$1107	1532	1959	2451	2388	1107	
	20-	\$1107	1532	1959	2451	2388	1107	
						3E	4E	4Z
2J-30	18-			\$1227	1573	1941		
	20-			\$1227	1573	1941		
2J-36	18-			\$1355	1733	2166		
	20-			\$1355	1733	2166		
2J-42	18-			\$1532	1959	2451		
	20-			\$1532	1959	2451		

Step 5. Paint/Steel Type

SS smooth paint on smooth steel A +\$0

TS smooth paint on textured steel A +\$35

XS textured paint on smooth steel A +\$0

Step 6. Case Finish

Nonmetallic Paint

For smooth paint on smooth steel (SS) or smooth paint on textured steel (TS)

8Q folkstone grey A +\$0

91 white A +\$0

98 studio white A +\$0

9J sparrow A +\$0

BU black umber A +\$0

G2 graphite satin A +\$0

HF inner tone light A +\$0

HT inner tone A +\$0

LT light tone A +\$0

LU soft white A +\$0

MT medium tone A +\$0

SG slate grey A +\$0

WA wheat A +\$0

WL sandstone A +\$0

Metallic Paint

For smooth paint on smooth steel (SS) or smooth paint on textured steel (TS)

1209 platinum A +\$65

1210 hematite A +\$65

1212 bronzite A +\$65

CN metallic champagne A +\$65

EH metallic bronze A +\$65

MS metallic silver A +\$65

Sand Texture Paint

For textured paint on smooth steel (XS)

98 studio white A +\$0

Bright Sand Texture Paint

For textured paint on smooth steel (XS)

91 white A +\$0

CL cool grey neutral A +\$0

G1 graphite A +\$0

WN warm grey neutral A +\$0

Ellipse-Pull Freestanding Lateral File *continued*

Step 7. Front Finish

Nonmetallic Paint

For smooth paint on smooth steel (SS) or smooth paint on textured steel (TS)

8Q	folkstone grey <input type="checkbox"/>	+\$0
91	white <input type="checkbox"/>	+\$0
98	studio white <input type="checkbox"/>	+\$0
9J	sparrow <input type="checkbox"/>	+\$0
BU	black umber <input type="checkbox"/>	+\$0
G2	graphite satin <input type="checkbox"/>	+\$0
HF	inner tone light <input type="checkbox"/>	+\$0
HT	inner tone <input type="checkbox"/>	+\$0
LT	light tone <input type="checkbox"/>	+\$0
LU	soft white <input type="checkbox"/>	+\$0
MT	medium tone <input type="checkbox"/>	+\$0
SG	slate grey <input type="checkbox"/>	+\$0
WA	wheat <input type="checkbox"/>	+\$0
WL	sandstone <input type="checkbox"/>	+\$0

Metallic Paint

For smooth paint on smooth steel (SS) or smooth paint on textured steel (TS)

1209	platinum <input type="checkbox"/>	+\$0
1210	hematite <input type="checkbox"/>	+\$0
1212	bronzite <input type="checkbox"/>	+\$0
CN	metallic champagne <input type="checkbox"/>	+\$0
EH	metallic bronze <input type="checkbox"/>	+\$0
MS	metallic silver <input type="checkbox"/>	+\$0

Sand Texture Paint

For textured paint on smooth steel (XS)

98	studio white <input type="checkbox"/>	+\$0
-----------	---------------------------------------	------

Bright Sand Texture Paint

For textured paint on smooth steel (XS)

91	white <input type="checkbox"/>	+\$0
CL	cool grey neutral <input type="checkbox"/>	+\$0
G1	graphite <input type="checkbox"/>	+\$0
WN	warm grey neutral <input type="checkbox"/>	+\$0

Step 8. Top

NT	no top <input type="checkbox"/>	+\$0
T1	1"-high painted metal top with squared edge <input type="checkbox"/>	+\$0
T2	1¼"-high painted metal top with squared edge <input type="checkbox"/>	+\$0
T3	1¼"-high painted metal top with radius edge <input type="checkbox"/>	+\$63
TL	1¼"-high laminate top with thermoplastic edge <input type="checkbox"/>	+\$72
TR	1¼"-high recut veneer top <input type="checkbox"/>	+\$147
TF	1¼"-high wood veneer top <input type="checkbox"/>	+\$152
T7	6½"-high planter top <input type="checkbox"/>	+\$196
D1	6½"-high full dome, side-to-side <input type="checkbox"/>	+\$267
H1	6½"-high half dome, sloping left <input type="checkbox"/>	+\$267
H2	6½"-high half dome, sloping right <input type="checkbox"/>	+\$267
TV1	1⅞"-high wood veneer top and wood composite edge with oversail front <input type="checkbox"/>	+\$314
TC1	1" cushion top <input type="checkbox"/>	+\$386
TC2	2" cushion top <input type="checkbox"/>	+\$386

Step 9. Lock

KA	keyed alike <input type="checkbox"/>	+\$0
KC	keyed differently, chrome <input type="checkbox"/>	+\$0
KD	keyed differently, black <input type="checkbox"/>	+\$0

For 2 11¾"-high drawers (2N), 3 11¾"-high drawers (3N), 4 11¾"-high drawers (4N), 5 11¾"-high drawers (5N), 2 13⅛"-high drawers (2E), 3 13⅛"-high drawers (3E), or 4 13⅛"-high drawers (4E) with no top (NT), or 1¼"-high laminate top with thermoplastic edge (TL), or 6½"-high planter top (T7), or 6½"-high full dome, side-to-side (D1), or 6½"-high half dome, sloping left (H1), or 6½"-high half dome, sloping right (H2), or 1⅞"-high wood veneer top and wood composite edge with oversail front (TV1)

NL	no lock <input type="checkbox"/>	-\$30
-----------	----------------------------------	-------

Step 10.

Veneer Top Finish: Wood Veneer

For 1¼"-high wood veneer top (TF)

2U	light brown walnut <input type="checkbox"/>	+\$28
40	dark brown walnut <input type="checkbox"/>	+\$28
ED	aged cherry <input type="checkbox"/>	+\$28
EK	medium red walnut <input type="checkbox"/>	+\$28
EW	medium matte walnut <input type="checkbox"/>	+\$28
ET	clear on ash <input type="checkbox"/>	+\$28
EU	oak on ash <input type="checkbox"/>	+\$28
EV	walnut on ash <input type="checkbox"/>	+\$28
UL	natural maple <input type="checkbox"/>	+\$28
UX	walnut on cherry <input type="checkbox"/>	+\$28

Ellipse-Pull Freestanding Lateral

File *continued*

Meridian® Freestanding Stackable™ Lateral Files

Top Finish: Solid-Color Laminate

For 1 1/4"-high laminate top with thermoplastic edge (TL)

8Q	folkstone grey A	+\$0
91	white A	+\$0
98	studio white	+\$0
CL	cool grey neutral A	+\$0
HF	inner tone light A	+\$0
HT	inner tone A	+\$0
LT	light tone A	+\$0
LU	soft white A	+\$0
WL	sandstone A	+\$0
WN	warm grey neutral A	+\$0

Top Finish: Linen Laminate

For 1 1/4"-high laminate top with thermoplastic edge (TL)

LBM	crisp linen	+\$0
LBN	classic linen	+\$0
LBP	casual linen	+\$0

Top Finish: Mesh Laminate

For 1 1/4"-high laminate top with thermoplastic edge (TL)

LBK	pewter mesh	+\$0
LBL	steel mesh	+\$0

Top Finish: Twill Laminate

For 1 1/4"-high laminate top with thermoplastic edge (TL)

LBF	neutral twill	+\$0
LBG	sarum twill	+\$0
LBH	earthen twill	+\$0
LBJ	graphite twill	+\$0
LBQ	white twill	+\$0

Top Finish: Wood-Grain Laminate

For 1 1/4"-high laminate top with thermoplastic edge (TL)

HM	natural maple A	+\$0
HP	light anigre A	+\$0
LA	light ash A	+\$0
LBA	clear on ash	+\$0
LBB	oak on ash	+\$0
LBC	walnut on ash	+\$0
LBD	dark brown walnut	+\$0
LBR	phantom ecru	+\$0
LBS	phantom cocoa	+\$0
LBU	medium matte walnut	+\$0
LBV	warm grey teak	+\$0
LBE	medium red walnut	+\$0
LM	mahogany A	+\$0
76	light brown walnut A	+\$0
HX	aged cherry A	+\$0
HY	walnut on cherry A	+\$0

Top Finish: Zephyr Laminate

For 1 1/4"-high laminate top with thermoplastic edge (TL)

28	canyon A	+\$0
29	misted A	+\$0

Veneer Top Finish: Recut Veneer

For 1 1/4"-high recut veneer top (TR)

RA	light ash A	+\$0
RK	mahogany dark A	+\$0
RM	mahogany A	+\$0

Veneer Top Finish: Wood Veneer

For 1 1/8"-high wood veneer top and wood composite edge with oversail front (TV1)

40	dark brown walnut A	+\$28
ED	aged cherry A	+\$28
EK	medium red walnut A	+\$28
EW	medium matte walnut A	+\$28
ET	clear on ash A	+\$28
EU	oak on ash A	+\$28
EV	walnut on ash A	+\$28
UL	natural maple A	+\$28
UX	walnut on cherry A	+\$28

Step 11. Edge Finish

For 1 1/4"-high laminate top with thermoplastic edge (TL)

28	canyon A	+\$0
29	misted A	+\$0

Ellipse-Pull Freestanding Lateral File *continued*

76	light brown walnut	A	+\$0
8Q	folkstone grey	A	+\$0
91	white	A	+\$0
BU	black umber	A	+\$0
CL	cool grey neutral	A	+\$0
G2	graphite satin	A	+\$0
HF	inner tone light	A	+\$0
HM	natural maple	A	+\$0
HP	light anigre	A	+\$0
HT	inner tone	A	+\$0
HX	aged cherry	A	+\$0
HY	walnut on cherry	A	+\$0
LA	light ash	A	+\$0
LBA	clear on ash		+\$0
LBB	oak on ash		+\$0
LBC	walnut on ash		+\$0
LBD	dark brown walnut		+\$0
LBR	phantom ecru		+\$0
LBS	phantom cocoa		+\$0
LBU	medium matte walnut		+\$0
LBV	warm grey teak		+\$0
LBE	medium red walnut		+\$0
LBK	pewter mesh		+\$0
LBL	steel mesh		+\$0
LBM	crisp linen		+\$0
LBN	classic linen		+\$0
LBP	casual linen		+\$0
LBF	neutral twill		+\$0
LBG	sarum twill		+\$0
LBH	earthen twill		+\$0
LBJ	graphite twill		+\$0
LBQ	white twill		+\$0
LM	mahogany	A	+\$0
LU	soft white	A	+\$0
MT	medium tone	A	+\$0
SG	slate grey	A	+\$0
WA	wheat	A	+\$0
WL	sandstone	A	+\$0
WN	warm grey neutral	A	+\$0

Step 12. Cushion Top Fabric

For 1" cushion top (TC1) or 2" cushion top (TC2)

See textiles list for fabric numbers. First 2 digits of number indicate fabric line; remaining digit(s) indicate fabric color.

Price Category 1	+\$0	
Price Category 2	+\$68	
Price Category 3	+\$82	
Price Category 4	+\$101	
Price Category 7	A	+\$137
Price Category 9	+\$950	
Price Category B	+\$47	
Price Category E	+\$99	
Price Category G	+\$166	
Price Category H	+\$204	

Step 13. Base Height

B1	1"-high base	A	+\$0
B2	1½"-high base	A	+\$0
B3	2¼"-high base	A	+\$0
B4	3¼"-high base	A	+\$0
BA	1"-high recessed base	A	+\$33
BB	1½"-high recessed base	A	+\$33
BC	2¼"-high recessed base	A	+\$33
BD	3¼"-high recessed base	A	+\$33
B5	4¼"-high base	A	+\$33

Step 14. Counterweight

NO	no counterweight (must gang or anchor)	A	+\$0
CB	counterweight (recommended)	A	+\$119

Step 15. Drawer Interior

9P	front-to-back filing rail	A	+\$0
9R	side-to-side filing rail	A	+\$0
9M	3 dividers	A	+\$0

Step 16. Overhead Interior

For 1 26¼"-high overhead storage, 3 11¾"-high drawers (4W) or 1 26¼"-high overhead storage, 3 13¾"-high drawers (4Z)

NS0	no interior option	A	-\$33
NS1	1 shelf total	A	+\$0
NS2	2 shelves total	A	+\$33

Sloped-Pull Freestanding Lateral File

29P-3
29P-4
29V-3
29V-4

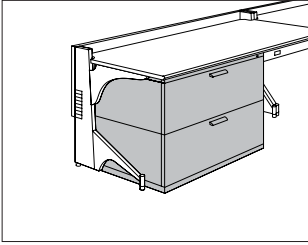

Product Information

Description

This lateral file holds letter-, legal-, and A4-size hanging files. It has sloped pulls and smooth or textured steel. The file has no top or a metal, cushion, laminate, planter, or veneer top. A positive interlock system permits only 1 drawer to open at a time. 1 lock controls all drawers. The drawers can be specified with 3 dividers or with front-to-back or side-to-side filing rails for hanging files. 5 base heights are available; all bases include adjustable glides.

Actual lateral file widths are $29\frac{7}{8}$ " , $35\frac{7}{8}$ " , or $41\frac{7}{8}$ " ; actual depths are $17\frac{7}{8}$ " or $19\frac{7}{8}$ " .

Notes

For 2- or 3-high files that are not ganged or anchored, counterweights (option CB) are required. For 4- or 5-high files that are not ganged or anchored, counterweights are recommended.

Dimensional illustrations do not include all possible configurations.

To convert filing direction, order 1 of the following products separately:

- Front-to-back rail (gPxxxx)
- Side-to-side rail (gRxxxx)

See Stackable Lateral File Accessories for specific product number.

Order optional file drawer organizer (LG901) separately.

For work surface on top of 1 or more lateral files, order file top (TPL or TPV) separately.

No lock option (NL) can only be specified on files with no top (NT), dome tops (D1, H1, or H2), planter top (T7), laminate tops (TL), or veneer top (TV1).

For cushion tops TC1 and TC2, a 1" metal top is included.

Grain direction is vertical for veneer-front lateral files.

Cushion top accepts Customer's Own Material (COM). Yardage is estimated for nondirectional, 54"-wide fabrics. When ordering more than 1 cushion, round up total yardage requirement to next whole yard of fabric.

Width—Yardage

30"—1.05

36"—1.22

42"—1.40

For information on multiple quantities or directional fabrics, contact COM Department. See Order Information in Appendices.

For keyed-alike locks, order lock plugs separately. See Keyed-Alike Information in Appendices.

Dimensions

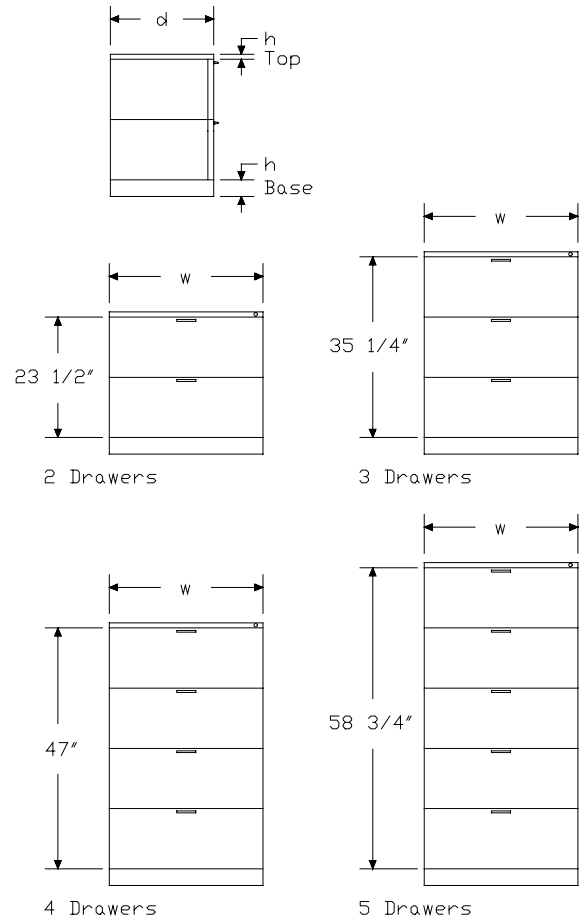

Sloped-Pull Freestanding Lateral

File *continued*

Specification Information

Step 1.

29

Step 2. Front Material

- P-** painted metal front
- V-** veneer front A

Step 3. Width

- 30** 30" wide
- 36** 36" wide
- 42** 42" wide

Step 4. Depth

- 18-** 18" deep
- 20-** 20" deep

Step 5. Configuration

- 2N** 2 drawers
- 3N** 3 drawers
- 4N** 4 drawers
- 5N** 5 drawers

Prices for Steps 1-5.

		2N	3N	4N	5N
29P-30	18-	\$882	1227	1573	1919
	20-	\$882	1227	1573	1919
29P-36	18-	\$979	1356	1734	2112
	20-	\$979	1356	1734	2112
29P-42	18-	\$1109	1534	1960	2387
	20-	\$1109	1534	1960	2387
29V-30	18-	\$1242	1770	2294	2824
	20-	\$1242	1770	2294	2824
29V-36	18-	\$1412	2006	2601	3196
	20-	\$1412	2006	2601	3196
29V-42	18-	\$1609	2286	2966	3642
	20-	\$1609	2286	2966	3642

Step 6. Paint/Steel Type

- SS** smooth paint on smooth steel +\$0
- TS** smooth paint on textured steel +\$35
- XS** textured paint on smooth steel +\$0

Step 7. Surface Finish

Nonmetallic Paint

For smooth paint on smooth steel (SS) or smooth paint on textured steel (TS)

8Q	folkstone grey	+\$0
91	white	+\$0
98	studio white A	+\$0
9J	sparrow	+\$0
BU	black umber	+\$0
G2	graphite satin	+\$0
HF	inner tone light	+\$0
HT	inner tone	+\$0
LT	light tone	+\$0
LU	soft white	+\$0
MT	medium tone	+\$0
SG	slate grey	+\$0
WA	wheat	+\$0
WL	sandstone	+\$0

Metallic Paint

For smooth paint on smooth steel (SS) or smooth paint on textured steel (TS)

1209	platinum	+\$65
1210	hematite	+\$65
1212	bronzite	+\$65
CN	metallic champagne	+\$65
EH	metallic bronze	+\$65
MS	metallic silver	+\$65

Sand Texture Paint

For textured paint on smooth steel (XS)

98	studio white A	+\$0
-----------	--	------

Bright Sand Texture Paint

For textured paint on smooth steel (XS)

91	white	+\$0
CL	cool grey neutral	+\$0
G1	graphite	+\$0
WN	warm grey neutral	+\$0

Sloped-Pull Freestanding Lateral File *continued*

Step 8. Top

For painted metal front (P-)

NT	no top	+\$0
T1	1"-high painted metal top with squared edge	+\$0
T2	1 1/4"-high painted metal top with squared edge	+\$0
T3	1 1/4"-high painted metal top with radius edge	+\$63
TL	1 1/4"-high laminate top with thermoplastic edge	+\$72
TR	1 1/4"-high recut veneer top A	+\$147
TF	1 1/4"-high wood veneer top A	+\$152
T7	6 1/2"-high planter top	+\$196
D1	6 1/2"-high full dome, side-to-side	+\$267
H1	6 1/2"-high half dome, sloping left	+\$267
H2	6 1/2"-high half dome, sloping right	+\$267
TV1	1 1/8"-high wood veneer top and wood composite edge with oversail front A	+\$314
TC1	1" cushion top	+\$386
TC2	2" cushion top	+\$386

For veneer front (V-)

NT	no top	+\$0
T1	1"-high painted metal top with squared edge	+\$0
T2	1 1/4"-high painted metal top with squared edge	+\$0
T3	1 1/4"-high painted metal top with radius edge	+\$63
TL	1 1/4"-high laminate top with thermoplastic edge	+\$72
TF	1 1/4"-high wood veneer top A	+\$152
T7	6 1/2"-high planter top	+\$196
D1	6 1/2"-high full dome, side-to-side	+\$267
H1	6 1/2"-high half dome, sloping left	+\$267
H2	6 1/2"-high half dome, sloping right	+\$267
TV1	1 1/8"-high wood veneer top and wood composite edge with oversail front A	+\$314
TC1	1" cushion top	+\$386
TC2	2" cushion top	+\$386

Step 9.

Veneer Front Finish: Wood Veneer

For veneer front (V-) with no top (NT), 1"-high painted metal top with squared edge (T1), 1 1/4"-high painted metal top with squared edge (T2), 1 1/4"-high painted metal top with radius edge (T3), 1 1/4"-high laminate top with thermoplastic edge (TL), 6 1/2"-high planter top (T7), 6 1/2"-high full dome, side-to-side (D1), 6 1/2"-high half dome, sloping left (H1), 6 1/2"-high half dome, sloping right (H2), or 1" cushion top (TC1), or 2" cushion top (TC2)

2U	light brown walnut A	+\$56
40	dark brown walnut A	+\$56
ED	aged cherry A	+\$56
EK	medium red walnut A	+\$56
EW	medium matte walnut A	+\$56
ET	clear on ash A	+\$56
EU	oak on ash A	+\$56
EV	walnut on ash A	+\$56
UL	natural maple A	+\$56
UX	walnut on cherry A	+\$56

Veneer Top Finish: Wood Veneer

For painted metal front (P-) with 1 1/4"-high wood veneer top (TF)

2U	light brown walnut A	+\$28
40	dark brown walnut A	+\$28
ED	aged cherry A	+\$28
EK	medium red walnut A	+\$28
EW	medium matte walnut A	+\$28
ET	clear on ash A	+\$28
EU	oak on ash A	+\$28
EV	walnut on ash A	+\$28
UL	natural maple A	+\$28
UX	walnut on cherry A	+\$28

Veneer Front/Top Finish: Wood Veneer

For veneer front (V-) with 1 1/8"-high wood veneer top and wood composite edge with oversail front (TV1)

40	dark brown walnut A	+\$56
ED	aged cherry A	+\$56
EK	medium red walnut A	+\$56
EW	medium matte walnut A	+\$56
ET	clear on ash A	+\$56
EU	oak on ash A	+\$56
EV	walnut on ash A	+\$56
UL	natural maple A	+\$56
UX	walnut on cherry A	+\$56

Sloped-Pull Freestanding Lateral File *continued*

Veneer Top Finish: Wood Veneer

For painted metal front (P-) with 1 1/8"-high wood veneer top and wood composite edge with oversail front (TV1)

40	dark brown walnut <input type="checkbox"/>	+\$28
ED	aged cherry <input type="checkbox"/>	+\$28
EK	medium red walnut <input type="checkbox"/>	+\$28
EW	medium matte walnut <input type="checkbox"/>	+\$28
ET	clear on ash <input type="checkbox"/>	+\$28
EU	oak on ash <input type="checkbox"/>	+\$28
EV	walnut on ash <input type="checkbox"/>	+\$28
UL	natural maple <input type="checkbox"/>	+\$28
UX	walnut on cherry <input type="checkbox"/>	+\$28

Veneer Front/Top Finish: Wood Veneer

For veneer front (V-) with 1 1/4"-high wood veneer top (TF)

2U	light brown walnut <input type="checkbox"/>	+\$56
40	dark brown walnut <input type="checkbox"/>	+\$56
ED	aged cherry <input type="checkbox"/>	+\$56
EK	medium red walnut <input type="checkbox"/>	+\$56
EW	medium matte walnut <input type="checkbox"/>	+\$56
ET	clear on ash <input type="checkbox"/>	+\$56
EU	oak on ash <input type="checkbox"/>	+\$56
EV	walnut on ash <input type="checkbox"/>	+\$56
UL	natural maple <input type="checkbox"/>	+\$56
UX	walnut on cherry <input type="checkbox"/>	+\$56

Step 10. Top Finish

For 1 1/4"-high laminate top with thermoplastic edge (TL)

Solid-Color Laminate

8Q	folkstone grey	+\$0
91	white	+\$0
98	studio white	+\$0
CL	cool grey neutral	+\$0
HF	inner tone light	+\$0
HT	inner tone	+\$0
LT	light tone	+\$0
LU	soft white	+\$0
WL	sandstone	+\$0
WN	warm grey neutral	+\$0

Linen Laminate

LBM	crisp linen	+\$0
LBN	classic linen	+\$0
LBP	casual linen	+\$0

Mesh Laminate

LBK	pewter mesh	+\$0
LBL	steel mesh	+\$0

Twill Laminate

LBF	neutral twill	+\$0
LBG	sarum twill	+\$0
LBH	earthen twill	+\$0
LBJ	graphite twill	+\$0
LBQ	white twill	+\$0

Wood-Grain Laminate

HM	natural maple	+\$0
HP	light anigre	+\$0
LA	light ash	+\$0
LBA	clear on ash	+\$0
LBB	oak on ash	+\$0
LBC	walnut on ash	+\$0
LBD	dark brown walnut	+\$0
LBR	phantom ecru	+\$0
LBS	phantom cocoa	+\$0
LBU	medium matte walnut	+\$0
LBV	warm grey teak	+\$0
LBE	medium red walnut	+\$0
LM	mahogany	+\$0
76	light brown walnut	+\$0
HX	aged cherry	+\$0
HY	walnut on cherry	+\$0

Zephyr Laminate

28	canyon	+\$0
29	misted	+\$0

Step 11. Edge Finish

For 1 1/4"-high laminate top with thermoplastic edge (TL)

28	canyon	+\$0
29	misted	+\$0
76	light brown walnut	+\$0
8Q	folkstone grey	+\$0
91	white	+\$0
BU	black umber	+\$0
CL	cool grey neutral	+\$0
G2	graphite satin	+\$0
HF	inner tone light	+\$0
HM	natural maple	+\$0
HP	light anigre	+\$0
HT	inner tone	+\$0

Sloped-Pull Freestanding Lateral

File *continued*

HX	aged cherry	+\$0
HY	walnut on cherry	+\$0
LA	light ash	+\$0
LBA	clear on ash	+\$0
LBB	oak on ash	+\$0
LBC	walnut on ash	+\$0
LBD	dark brown walnut	+\$0
LBR	phantom ecru	+\$0
LBS	phantom cocoa	+\$0
LBU	medium matte walnut	+\$0
LBV	warm grey teak	+\$0
LBE	medium red walnut	+\$0
LBK	pewter mesh	+\$0
LBL	steel mesh	+\$0
LBM	crisp linen	+\$0
LBN	classic linen	+\$0
LBP	casual linen	+\$0
LBF	neutral twill	+\$0
LBG	sarum twill	+\$0
LBH	earthen twill	+\$0
LBJ	graphite twill	+\$0
LBQ	white twill	+\$0
LM	mahogany	+\$0
LU	soft white	+\$0
MT	medium tone	+\$0
SG	slate grey	+\$0
WA	wheat	+\$0
WL	sandstone	+\$0
WN	warm grey neutral	+\$0

Step 12. Cushion Top Fabric

*For 1" cushion top (TC1) or 2" cushion top (TC2)
See textiles list for fabric numbers. First 2 digits of number indicate fabric line; remaining digit(s) indicate fabric color.*

Price Category 1	+\$0
Price Category 2	+\$68
Price Category 3	+\$82
Price Category 4	+\$101
Price Category 9	+\$950
Price Category B	+\$47
Price Category E	+\$99
Price Category G	+\$166
Price Category H	+\$204

Step 13. Lock

For no top (NT), 1 1/4"-high laminate top with thermoplastic edge (TL), 6 1/2"-high planter top (T7), 6 1/2"-high full dome, side-to-side (D1), 6 1/2"-high half dome, sloping left (H1), 6 1/2"-high half dome, sloping right (H2), or 1 1/8"-high wood veneer top and wood composite edge with oversail front (TV1)

NL	no lock	-\$30
-----------	---------	-------

For 1"-high painted metal top with squared edge (T1), 1 1/4"-high painted metal top with squared edge (T2), 1 1/4"-high painted metal top with radius edge (T3), 1 1/4"-high recut veneer top (TR), 1 1/4"-high wood veneer top (TF), 1" cushion top (TC1), or 2" cushion top (TC2)

KA	keyed alike	+\$0
KC	keyed differently, chrome	+\$0
KD	keyed differently, black	+\$0

Step 14. Pull Finish

G2	graphite satin	+\$0
U1	brushed aluminum	+\$0

Step 15. Base Height

B1	1"-high base	+\$0
B2	1 1/2"-high base	+\$0
B3	2 1/4"-high base	+\$0
B4	3 1/4"-high base	+\$0
BA	1"-high recessed base	+\$33
BB	1 1/2"-high recessed base	+\$33
BC	2 1/4"-high recessed base	+\$33
BD	3 1/4"-high recessed base	+\$33
B5	4 1/4"-high base	+\$33

Step 16. Counterweight

NO	no counterweight (must gang or anchor)	+\$0
CB	counterweight (recommended)	+\$119

Step 17. Drawer Interior

9P	front-to-back filing rail	+\$0
9R	side-to-side filing rail	+\$0
9M	3 dividers	+\$0

Retrofit Cushion Top

TC1-3
TC1-4
TC2-3
TC2-4

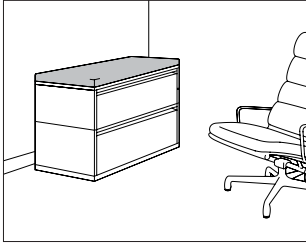

Product Information

Description

This cushion top is retrofit to a lateral file or storage case with a flat metal top. It is available in 2 heights, 3 widths, and 2 depths. Hook-and-loop fastener strips are included to attach cushion to flat metal top.

Notes

Cushion top accepts Customer's Own Material (COM). Yardage is estimated for nondirectional, 54"-wide fabrics. When ordering more than 1 cushion, round up total yardage requirement to next whole yard of fabric.

Width—Yardage

30" — 1.05

36" — 1.22

42" — 1.40

For information on multiple quantities or directional fabrics, contact COM Department. See Order Information in Appendices.

Dimensions

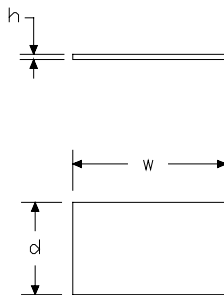

Specification Information

Step 1.

TC

Step 2. Height

1- 1" high

2- 2" high

Step 3. Width

30 30" wide

36 36" wide

42 42" wide

Step 4. Depth

18 18" deep

20 20" deep

Prices for Steps 1-4.

TC1-30	18	\$375
	20	\$375
TC1-36	18	\$375
	20	\$375
TC1-42	18	\$375
	20	\$375
TC2-30	18	\$375
	20	\$375
TC2-36	18	\$375
	20	\$375
TC2-42	18	\$375
	20	\$375

Retrofit Cushion Top *continued*

Step 5. Cushion Top Fabric	
<i>See textiles list for fabric numbers. First 2 digits of number indicate fabric line; remaining digit(s) indicate fabric color.</i>	
Price Category 1	+\$0
Price Category 2	+\$68
Price Category 3	+\$82
Price Category 4	+\$101
Price Category 7 A	+\$137
Price Category 9	+\$950
Price Category B	+\$47
Price Category E	+\$99
Price Category G	+\$166
Price Category H	+\$204

Standard-Pull Mobile Lateral File

M26-3
M26-4

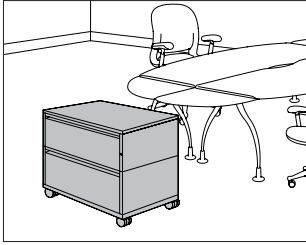

Product Information

Description

This lateral file holds letter-, legal-, and A4-size hanging files. It has standard pulls and smooth or textured steel. The file has a metal, cushion, laminate, planter, or veneer top. A positive interlock system permits only 1 drawer to open at a time. 1 lock controls all drawers. The drawers can be specified with 3 dividers or with front-to-back or side-to-side filing rails for hanging files. The 4³/₄"-high mobile base has a 1¹/₂"-high base frame with 3¹/₄"-high outset casters. The 2 swivel and 2 fixed casters must be field installed.

Actual lateral file widths are 29⁷/₈", 35⁷/₈", or 41⁷/₈"; actual depths are 17⁷/₈" or 19⁷/₈".

Notes

Dimensional illustrations do not include all possible configurations. To convert filing direction, order 1 of the following products separately:

- Front-to-back rail (9Pxxxx)
- Side-to-side rail (9Rxxxx)

See Stackable Lateral File Accessories for specific product number. Order optional file drawer organizer (LG901) separately. For cushion tops TC1 and TC2, a 1" metal top is included. Cushion top accepts Customer's Own Material (COM). Yardage is estimated for nondirectional, 54"-wide fabrics. When ordering more than 1 cushion, round up total yardage requirement to next whole yard of fabric.

Width—Yardage

30" —1.05
36" —1.22
42" —1.40

For information on multiple quantities or directional fabrics, contact COM Department. See Order Information in Appendices. For keyed-alike locks, order lock plugs separately. See Keyed-Alike Information in Appendices.

Dimensions

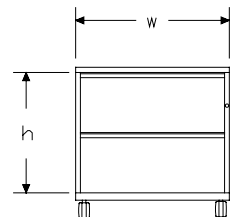
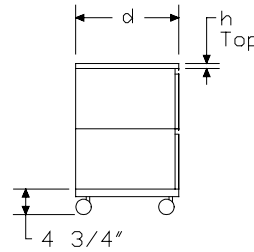

2 Drawers (2N, 2E)

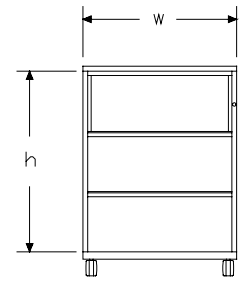

2 Drawers and Pass Through (KNN, KEE)

h	N	E	NN	EE
2	23 1/2	26 1/4	-	-
K	-	-	36 5/8	39 3/8

All dimensions are in inches.

Meridian® Mobile Stackable™ Lateral Files

Standard-Pull Mobile Lateral File

continued

Meridian® Mobile Stackable™ Lateral Files

Specification Information

Step 1.

M26-

Step 2. Width

30	30" wide
36	36" wide
42	42" wide

Step 3. Depth

18-	18" deep
20-	20" deep

Step 4. Configuration

2N	2 11 ³ / ₄ "-high drawers
2E	2 13 ¹ / ₈ "-high drawers
KNN	pass-through unit, 2 11 ³ / ₄ "-high drawers
KEE	pass-through unit, 2 13 ¹ / ₈ "-high drawers

Prices for Steps 1-4.

	2N	2E	KNN	KEE
M26-30 18-	\$1150	1150	1479	1479
20-	\$1150	1150	1479	1479
M26-36 18-	\$1251	1251	1603	1603
20-	\$1251	1251	1603	1603
M26-42 18-	\$1376	1376	1774	1774
20-	\$1376	1376	1774	1774

Step 5. Paint/Steel Type

SS	smooth paint on smooth steel	+\$0
TS	smooth paint on textured steel	+\$35
XS	textured paint on smooth steel	+\$0

Step 6. Surface Finish

Nonmetallic Paint

For smooth paint on smooth steel (SS) or smooth paint on textured steel (TS)

8Q	folkstone grey	+\$0
91	white	+\$0
98	studio white A	+\$0
9J	sparrow	+\$0
BU	black umber	+\$0
G2	graphite satin	+\$0
HF	inner tone light	+\$0
HT	inner tone	+\$0
LT	light tone	+\$0
LU	soft white	+\$0
MT	medium tone	+\$0
SG	slate grey	+\$0
WA	wheat	+\$0
WL	sandstone	+\$0

Metallic Paint

For smooth paint on smooth steel (SS) or smooth paint on textured steel (TS)

1209	platinum	+\$65
1210	hematite	+\$65
1212	bronzite	+\$65
CN	metallic champagne	+\$65
EH	metallic bronze	+\$65
MS	metallic silver	+\$65

Sand Texture Paint

For textured paint on smooth steel (XS)

98	studio white A	+\$0
-----------	-----------------------	------

Bright Sand Texture Paint

For textured paint on smooth steel (XS)

91	white	+\$0
CL	cool grey neutral	+\$0
G1	graphite	+\$0
WN	warm grey neutral	+\$0

Standard-Pull Mobile Lateral File

continued

Step 7. Top

T1	1"-high painted metal top with squared edge	+\$0
T2	1 1/4"-high painted metal top with squared edge	+\$0
T3	1 1/4"-high painted metal top with radius edge	+\$63
TL	1 1/4"-high laminate top with thermoplastic edge	+\$72
TR	1 1/4"-high recut veneer top <input type="checkbox"/> A	+\$147
TF	1 1/4"-high wood veneer top <input type="checkbox"/> A	+\$152
T7	6 1/2"-high planter top	+\$196
D1	6 1/2"-high full dome, side-to-side	+\$267
H1	6 1/2"-high half dome, sloping left	+\$267
H2	6 1/2"-high half dome, sloping right	+\$267
TV1	1 1/8"-high wood veneer top and wood composite edge with oversail front <input type="checkbox"/> A	+\$314
TC1	1" cushion top	+\$386
TC2	2" cushion top	+\$386

Step 8.

Veneer Top Finish

For 1 1/4"-high wood veneer top (TF)

2U	light brown walnut <input type="checkbox"/> A	+\$28
40	dark brown walnut <input type="checkbox"/> A	+\$28
ED	aged cherry <input type="checkbox"/> A	+\$28
EK	medium red walnut <input type="checkbox"/> A	+\$28
EW	medium matte walnut <input type="checkbox"/> A	+\$28
ET	clear on ash <input type="checkbox"/> A	+\$28
EU	oak on ash <input type="checkbox"/> A	+\$28
EV	walnut on ash <input type="checkbox"/> A	+\$28
UL	natural maple <input type="checkbox"/> A	+\$28
UX	walnut on cherry <input type="checkbox"/> A	+\$28

Veneer Top Finish

For 1 1/4"-high recut veneer top (TR)

RA	light ash <input type="checkbox"/> A	+\$0
RK	mahogany dark <input type="checkbox"/> A	+\$0
RM	mahogany <input type="checkbox"/> A	+\$0

Top Finish: Solid-Color Laminate

For 1 1/4"-high laminate top with thermoplastic edge (TL)

8Q	folkstone grey	+\$0
91	white	+\$0
98	studio white	+\$0
CL	cool grey neutral	+\$0
HF	inner tone light	+\$0
HT	inner tone	+\$0
LT	light tone	+\$0
LU	soft white	+\$0
WL	sandstone	+\$0
WN	warm grey neutral	+\$0

Top Finish: Linen Laminate

For 1 1/4"-high laminate top with thermoplastic edge (TL)

LBM	crisp linen	+\$0
LBN	classic linen	+\$0
LBP	casual linen	+\$0

Top Finish: Mesh Laminate

For 1 1/4"-high laminate top with thermoplastic edge (TL)

LBK	pewter mesh	+\$0
LBL	steel mesh	+\$0

Top Finish: Twill Laminate

For 1 1/4"-high laminate top with thermoplastic edge (TL)

LBF	neutral twill	+\$0
LBG	sarum twill	+\$0
LBH	earthen twill	+\$0
LBJ	graphite twill	+\$0
LBQ	white twill	+\$0

Standard-Pull Mobile Lateral File

continued

Meridian® Mobile Stackable™ Lateral Files

Top Finish: Wood-Grain Laminate

For 1 1/4"-high laminate top with thermoplastic edge (TL)

HM	natural maple	+\$0
HP	light anigre	+\$0
LA	light ash	+\$0
LBA	clear on ash	+\$0
LBB	oak on ash	+\$0
LBC	walnut on ash	+\$0
LBD	dark brown walnut	+\$0
LBR	phantom ecru	+\$0
LBS	phantom cocoa	+\$0
LBU	medium matte walnut	+\$0
LBV	warm grey teak	+\$0
LBE	medium red walnut	+\$0
LM	mahogany	+\$0
76	light brown walnut	+\$0
HX	aged cherry	+\$0
HY	walnut on cherry	+\$0

Top Finish: Zephyr Laminate

For 1 1/4"-high laminate top with thermoplastic edge (TL)

28	canyon	+\$0
29	misted	+\$0

Veneer Top Finish

For 1 1/8"-high wood veneer top and wood composite edge with oversail front (TV1)

40	dark brown walnut A	+\$28
ED	aged cherry A	+\$28
EK	medium red walnut A	+\$28
EW	medium matte walnut A	+\$28
ET	clear on ash A	+\$28
EU	oak on ash A	+\$28
EV	walnut on ash A	+\$28
UL	natural maple A	+\$28
UX	walnut on cherry A	+\$28

Step 9. Edge Finish

For 1 1/4"-high laminate top with thermoplastic edge (TL)

28	canyon	+\$0
29	misted	+\$0
76	light brown walnut	+\$0
8Q	folkstone grey	+\$0
91	white	+\$0
BU	black umber	+\$0
CL	cool grey neutral	+\$0
G2	graphite satin	+\$0

HF	inner tone light	+\$0
HM	natural maple	+\$0
HP	light anigre	+\$0
HT	inner tone	+\$0
HX	aged cherry	+\$0
HY	walnut on cherry	+\$0
LA	light ash	+\$0
LBA	clear on ash	+\$0
LBB	oak on ash	+\$0
LBC	walnut on ash	+\$0
LBD	dark brown walnut	+\$0
LBR	phantom ecru	+\$0
LBS	phantom cocoa	+\$0
LBU	medium matte walnut	+\$0
LBV	warm grey teak	+\$0
LBE	medium red walnut	+\$0
LBK	pewter mesh	+\$0
LBL	steel mesh	+\$0
LBM	crisp linen	+\$0
LBN	classic linen	+\$0
LBP	casual linen	+\$0
LBF	neutral twill	+\$0
LBG	sarum twill	+\$0
LBH	earthen twill	+\$0
LBJ	graphite twill	+\$0
LBQ	white twill	+\$0
LM	mahogany	+\$0
LU	soft white	+\$0
MT	medium tone	+\$0
SG	slate grey	+\$0
WA	wheat	+\$0
WL	sandstone	+\$0
WN	warm grey neutral	+\$0

Standard-Pull Mobile Lateral File

continued

Step 10. Cushion Top Fabric

For 1" cushion top (TC1) or 2" cushion top (TC2)

See textiles list for fabric numbers. First 2 digits of number indicate fabric line; remaining digit(s) indicate fabric color.

Price Category 1	+\$0
Price Category 2	+\$68
Price Category 3	+\$82
Price Category 4	+\$101
Price Category 7 A	+\$137
Price Category 9	+\$950
Price Category B	+\$47
Price Category E	+\$99
Price Category G	+\$166
Price Category H	+\$204

Step 11. Lock

KA	keyed alike	+\$0
KC	keyed differently, chrome	+\$0
KD	keyed differently, black	+\$0

Step 12. Drawer Interior

9M	3 dividers	+\$0
9P	front-to-back filing rail	+\$0
9R	side-to-side filing rail	+\$0

Bevel-Pull Mobile Lateral File

M24-3
M24-4

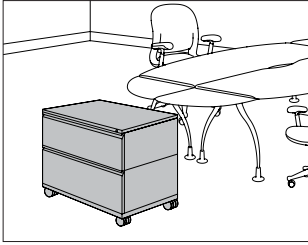

Meridian® Mobile Stackable™ Lateral Files

Product Information

Description

This lateral file holds letter-, legal-, and A4-size hanging files. It has bevel pulls and smooth or textured steel. The file has a metal, cushion, laminate, planter, or veneer top. A positive interlock system permits only 1 drawer to open at a time. 1 lock controls all drawers. The drawers can be specified with 3 dividers or with front-to-back or side-to-side filing rails for hanging files. The 4^{3/4}"-high mobile base has a 1^{1/2}"-high base frame with 3^{1/4}"-high outset casters. The 2 swivel and 2 fixed casters must be field installed.

Actual lateral file widths are 29^{7/8}", 35^{7/8}", or 41^{7/8}"; actual depths are 17^{7/8}" or 19^{7/8}".

Notes

Dimensional illustrations do not include all possible configurations.

To convert filing direction, order 1 of the following products separately:

- Front-to-back rail (gPxxxx)
- Side-to-side rail (gRxxxx)

See Stackable Lateral File Accessories for specific product number.

Order optional file drawer organizer (LG901) separately.

For cushion tops TC1 and TC2, a 1" metal top is included.

Cushion top accepts Customer's Own Material (COM). Yardage is estimated for nondirectional, 54"-wide fabrics. When ordering more than 1 cushion, round up total yardage requirement to next whole yard of fabric.

Width—Yardage

30"—1.05

36"—1.22

42"—1.40

For information on multiple quantities or directional fabrics, contact COM Department. See Order Information in Appendices.

For keyed-alike locks, order lock plugs separately. See Keyed-Alike Information in Appendices.

Dimensions

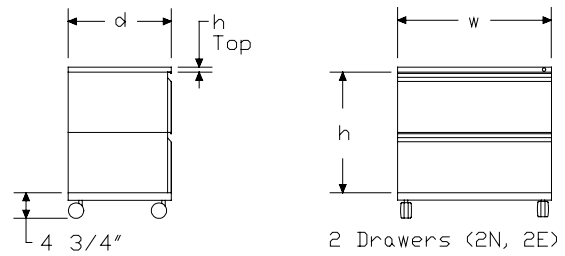

h	N	E
2	23 1/2	26 1/4

All dimensions are in inches.

Bevel-Pull Mobile Lateral File

continued

Specification Information

Step 1.

M24-

Step 2. Width

30	30" wide
36	36" wide
42	42" wide

Step 3. Depth

18-	18" deep
20-	20" deep

Step 4. Configuration

2N	2 11 ³ / ₄ "-high drawers
2E	2 13 ¹ / ₈ "-high drawers

Prices for Steps 1-4.

	2N	2E
M24-30 18-	\$1150	1150
20-	\$1150	1150
M24-36 18-	\$1251	1251
20-	\$1251	1251
M24-42 18-	\$1376	1376
20-	\$1376	1376

Step 5. Paint/Steel Type

SS	smooth paint on smooth steel	+\$0
TS	smooth paint on textured steel	+\$35
XS	textured paint on smooth steel	+\$0

Step 6. Surface Finish

Nonmetallic Paint

For smooth paint on smooth steel (SS) or smooth paint on textured steel (TS)

8Q	folkstone grey	+\$0
91	white	+\$0
98	studio white <input type="checkbox"/> A	+\$0
9J	sparrow	+\$0
BU	black umber	+\$0
G2	graphite satin	+\$0
HF	inner tone light	+\$0
HT	inner tone	+\$0
LT	light tone	+\$0
LU	soft white	+\$0
MT	medium tone	+\$0
SG	slate grey	+\$0
WA	wheat	+\$0
WL	sandstone	+\$0

Metallic Paint

For smooth paint on smooth steel (SS) or smooth paint on textured steel (TS)

1209	platinum	+\$65
1210	hematite	+\$65
1212	bronzite	+\$65
CN	metallic champagne	+\$65
EH	metallic bronze	+\$65
MS	metallic silver	+\$65

Sand Texture Paint

For textured paint on smooth steel (XS)

98	studio white <input type="checkbox"/> A	+\$0
-----------	---	------

Bright Sand Texture Paint

For textured paint on smooth steel (XS)

91	white	+\$0
CL	cool grey neutral	+\$0
G1	graphite	+\$0
WN	warm grey neutral	+\$0

Meridian® Mobile Stackable™ Lateral Files

Bevel-Pull Mobile Lateral File

continued

Meridian® Mobile Stackable™ Lateral Files

Step 7. Top		
T1	1"-high painted metal top with squared edge	+\$0
T2	1 1/4"-high painted metal top with squared edge	+\$0
T3	1 1/4"-high painted metal top with radius edge	+\$63
TL	1 1/4"-high laminate top with thermoplastic edge	+\$72
TR	1 1/4"-high recut veneer top A	+\$147
TF	1 1/4"-high wood veneer top A	+\$152
T7	6 1/2"-high planter top	+\$196
D1	6 1/2"-high full dome, side-to-side	+\$267
H1	6 1/2"-high half dome, sloping left	+\$267
H2	6 1/2"-high half dome, sloping right	+\$267
TV1	1 1/8"-high wood veneer top and wood composite edge with oversail front A	+\$314
TC1	1" cushion top	+\$386
TC2	2" cushion top	+\$386

Step 8. Lock		
<i>For 1"-high painted metal top with squared edge (T1), 1 1/4"-high painted metal top with squared edge (T2), 1 1/4"-high painted metal top with radius edge (T3), 1 1/4"-high recut veneer top (TR), 1 1/4"-high wood veneer top (TF), 1" cushion top (TC1), or 2" cushion top (TC2)</i>		
KA	keyed alike	+\$0
KC	keyed differently, chrome	+\$0
KD	keyed differently, black	+\$0

<i>For 1 1/4"-high laminate top with thermoplastic edge (TL), 6 1/2"-high planter top (T7), 6 1/2"-high full dome, side-to-side (D1), 6 1/2"-high half dome, sloping left (H1), 6 1/2"-high half dome, sloping right (H2), or 1 1/8"-high wood veneer top and wood composite edge with oversail front (TV1)</i>		
NL	no lock	-\$30

Step 9.		
Veneer Top Finish: Wood Veneer		
<i>For 1 1/4"-high wood veneer top (TF)</i>		
2U	light brown walnut A	+\$28
40	dark brown walnut A	+\$28
ED	aged cherry A	+\$28
EK	medium red walnut A	+\$28
EW	medium matte walnut A	+\$28
ET	clear on ash A	+\$28
EU	oak on ash A	+\$28
EV	walnut on ash A	+\$28
UL	natural maple A	+\$28
UX	walnut on cherry A	+\$28

Veneer Top Finish: Recut Veneer		
<i>For 1 1/4"-high recut veneer top (TR)</i>		
RA	light ash A	+\$0
RK	mahogany dark A	+\$0
RM	mahogany A	+\$0

Top Finish: Solid-Color Laminate		
<i>For 1 1/4"-high laminate top with thermoplastic edge (TL)</i>		
8Q	folkstone grey	+\$0
91	white	+\$0
98	studio white	+\$0
CL	cool grey neutral	+\$0
HF	inner tone light	+\$0
HT	inner tone	+\$0
LT	light tone	+\$0
LU	soft white	+\$0
WL	sandstone	+\$0
WN	warm grey neutral	+\$0

Top Finish: Linen Laminate		
<i>For 1 1/4"-high laminate top with thermoplastic edge (TL)</i>		
LBM	crisp linen	+\$0
LBN	classic linen	+\$0
LBP	casual linen	+\$0

Top Finish: Mesh Laminate		
<i>For 1 1/4"-high laminate top with thermoplastic edge (TL)</i>		
LBK	pewter mesh	+\$0
LBL	steel mesh	+\$0

Top Finish: Twill Laminate		
<i>For 1 1/4"-high laminate top with thermoplastic edge (TL)</i>		
LBF	neutral twill	+\$0
LBG	sarum twill	+\$0
LBH	earthen twill	+\$0
LBJ	graphite twill	+\$0
LBQ	white twill	+\$0

Bevel-Pull Mobile Lateral File

continued

Top Finish: Wood-Grain Laminate

For 1¹/₄"-high laminate top with thermoplastic edge (TL)

HM	natural maple	+\$0
HP	light anigre	+\$0
LA	light ash	+\$0
LBA	clear on ash	+\$0
LBB	oak on ash	+\$0
LBC	walnut on ash	+\$0
LBD	dark brown walnut	+\$0
LBR	phantom ecru	+\$0
LBS	phantom cocoa	+\$0
LBU	medium matte walnut	+\$0
LBV	warm grey teak	+\$0
LBE	medium red walnut	+\$0
LM	mahogany	+\$0
76	light brown walnut	+\$0
HX	aged cherry	+\$0
HY	walnut on cherry	+\$0

Top Finish: Zephyr Laminate

For 1¹/₄"-high laminate top with thermoplastic edge (TL)

28	canyon	+\$0
29	misted	+\$0

Veneer Top Finish: Wood Veneer

For 1¹/₈"-high wood veneer top and wood composite edge with oversail front (TV1)

40	dark brown walnut <input type="checkbox"/>	+\$28
ED	aged cherry <input type="checkbox"/>	+\$28
EK	medium red walnut <input type="checkbox"/>	+\$28
EW	medium matte walnut <input type="checkbox"/>	+\$28
ET	clear on ash <input type="checkbox"/>	+\$28
EU	oak on ash <input type="checkbox"/>	+\$28
EV	walnut on ash <input type="checkbox"/>	+\$28
UL	natural maple <input type="checkbox"/>	+\$28
UX	walnut on cherry <input type="checkbox"/>	+\$28

Step 10. Edge Finish

For 1¹/₄"-high laminate top with thermoplastic edge (TL)

28	canyon	+\$0
29	misted	+\$0
76	light brown walnut	+\$0
8Q	folkstone grey	+\$0
91	white	+\$0
BU	black umber	+\$0
CL	cool grey neutral	+\$0
G2	graphite satin	+\$0

HF	inner tone light	+\$0
HM	natural maple	+\$0
HP	light anigre	+\$0
HT	inner tone	+\$0
HX	aged cherry	+\$0
HY	walnut on cherry	+\$0
LA	light ash	+\$0
LBA	clear on ash	+\$0
LBB	oak on ash	+\$0
LBC	walnut on ash	+\$0
LBD	dark brown walnut	+\$0
LBR	phantom ecru	+\$0
LBS	phantom cocoa	+\$0
LBU	medium matte walnut	+\$0
LBV	warm grey teak	+\$0
LBE	medium red walnut	+\$0
LBK	pewter mesh	+\$0
LBL	steel mesh	+\$0
LBM	crisp linen	+\$0
LBN	classic linen	+\$0
LBP	casual linen	+\$0
LBF	neutral twill	+\$0
LBG	sarum twill	+\$0
LBH	earthen twill	+\$0
LBJ	graphite twill	+\$0
LBQ	white twill	+\$0
LM	mahogany	+\$0
LU	soft white	+\$0
MT	medium tone	+\$0
SG	slate grey	+\$0
WA	wheat	+\$0
WL	sandstone	+\$0
WN	warm grey neutral	+\$0

Meridian® Mobile Stackable™ Lateral Files

Bevel-Pull Mobile Lateral File

continued

Meridian® Mobile Stackable™ Lateral Files

Step 11. Cushion Top Fabric

For 1" cushion top (TC1) or 2" cushion top (TC2)

See textiles list for fabric numbers. First 2 digits of number indicate fabric line; remaining digit(s) indicate fabric color.

Price Category 1	+\$0
Price Category 2	+\$68
Price Category 3	+\$82
Price Category 4	+\$101
Price Category 7 A	+\$137
Price Category 9	+\$950
Price Category B	+\$47
Price Category E	+\$99
Price Category G	+\$166
Price Category H	+\$204

Step 12. Drawer Interior

9M	3 dividers	+\$0
9P	front-to-back filing rail	+\$0
9R	side-to-side filing rail	+\$0

Meridian® File Top

TPL-0
TPL-1

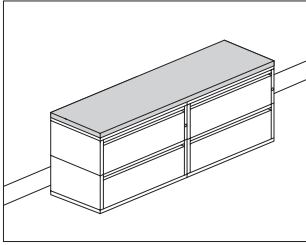

Product Information

Description

This file top attaches to a combination of freestanding Meridian® lateral files or storage cases with 18" or 20" depths. It has a laminate top with thermoplastic edge or a veneer top and edge.

Notes

Standard-pull files have lock located in side stile and do not require metal top under common top. Files with all other pull types will require metal top under common top to accommodate locks.

Suggested attachment methods:

- Double-face tape
- #10 wood screws with 1" maximum length

Additional sizes and open-line laminates available through Vary Easy® Exact Size Top Price Book (specIT edition only).

Dimensions

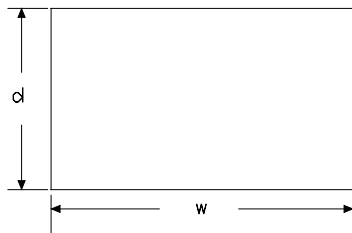
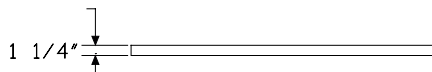

Specification Information

Step 1.

TP A

Step 2. Top/Edge Material

L- laminate top with thermoplastic edge A

Step 3. Width

- 030 30" wide A
- 036 36" wide A
- 042 42" wide A
- 060 60" wide A
- 072 72" wide A
- 084 84" wide A
- 090 90" wide A
- 108 108" wide A

Step 4. Depth

- 18 18" deep A
- 20 20" deep A
- 36 36" deep A
- 40 40" deep A

Prices for Steps 1-4.

TPL-030	18	\$146
	20	\$146
	36	\$326
	40	\$326
TPL-036	18	\$175
	20	\$175
	36	\$391
	40	\$391
TPL-042	18	\$203
	20	\$203
	36	\$454
	40	\$454
TPL-060	18	\$291
	20	\$291
	36	\$651
	40	\$651

TPL-072	18	\$349
	20	\$349
	36	\$781
	40	\$781
TPL-084	18	\$406
	20	\$406
	36	\$907
	40	\$907
TPL-090	18	\$436
	20	\$436
	36	\$977
	40	\$977
TPL-108	18	\$523
	20	\$523
	36	\$1172
	40	\$1172

Step 5. Top Finish

Solid-Color Laminate

8Q	folkstone grey <input type="checkbox"/>	+\$0
91	white <input type="checkbox"/>	+\$0
98	studio white	+\$0
CL	cool grey neutral <input type="checkbox"/>	+\$0
HF	inner tone light <input type="checkbox"/>	+\$0
HT	inner tone <input type="checkbox"/>	+\$0
LT	light tone <input type="checkbox"/>	+\$0
LU	soft white <input type="checkbox"/>	+\$0
WL	sandstone <input type="checkbox"/>	+\$0
WN	warm grey neutral <input type="checkbox"/>	+\$0

Linen Laminate

LBM	crisp linen	+\$0
LBN	classic linen	+\$0
LBP	casual linen	+\$0

Mesh Laminate

LBK	pewter mesh	+\$0
LBL	steel mesh	+\$0

Twill Laminate

LBF	neutral twill	+\$0
LBG	sarum twill	+\$0
LBH	earthen twill	+\$0
LBJ	graphite twill	+\$0
LBQ	white twill	+\$0

Wood-Grain Laminate

HM	natural maple <input type="checkbox"/>	+\$0
HP	light anigre <input type="checkbox"/>	+\$0
LA	light ash <input type="checkbox"/>	+\$0
LBA	clear on ash	+\$0
LBB	oak on ash	+\$0
LBC	walnut on ash	+\$0
LBD	dark brown walnut	+\$0
LBR	phantom ecru	+\$0
LBS	phantom cocoa	+\$0
LBU	medium matte walnut	+\$0
LBV	warm grey teak	+\$0
LBE	medium red walnut	+\$0
LM	mahogany <input type="checkbox"/>	+\$0
76	light brown walnut <input type="checkbox"/>	+\$0
HX	aged cherry <input type="checkbox"/>	+\$0
HY	walnut on cherry <input type="checkbox"/>	+\$0
28	canyon <input type="checkbox"/>	+\$0
29	misted <input type="checkbox"/>	+\$0

Step 6. Edge Finish

LT	light tone <input type="checkbox"/>	+\$0
28	canyon <input type="checkbox"/>	+\$0
29	misted <input type="checkbox"/>	+\$0
76	light brown walnut <input type="checkbox"/>	+\$0
8Q	folkstone grey <input type="checkbox"/>	+\$0
91	white <input type="checkbox"/>	+\$0
98	studio white	+\$0
BU	black umber <input type="checkbox"/>	+\$0
CL	cool grey neutral <input type="checkbox"/>	+\$0
G2	graphite satin <input type="checkbox"/>	+\$0
HF	inner tone light <input type="checkbox"/>	+\$0
HM	natural maple <input type="checkbox"/>	+\$0
HP	light anigre <input type="checkbox"/>	+\$0
HT	inner tone <input type="checkbox"/>	+\$0
HX	aged cherry <input type="checkbox"/>	+\$0
HY	walnut on cherry <input type="checkbox"/>	+\$0
LA	light ash <input type="checkbox"/>	+\$0
LBA	clear on ash	+\$0
LBB	oak on ash	+\$0

LBC	walnut on ash	+\$0
LBD	dark brown walnut	+\$0
LBR	phantom ecru	+\$0
LBS	phantom cocoa	+\$0
LBU	medium matte walnut	+\$0
LBV	warm grey teak	+\$0
LBE	medium red walnut	+\$0
LBK	pewter mesh <input type="checkbox"/> A	+\$0
LBL	steel mesh <input type="checkbox"/> A	+\$0
LBM	crisp linen <input type="checkbox"/> A	+\$0
LBN	classic linen <input type="checkbox"/> A	+\$0
LBP	casual linen <input type="checkbox"/> A	+\$0
LBF	neutral twill <input type="checkbox"/> A	+\$0
LBG	sarum twill <input type="checkbox"/> A	+\$0
LBH	earthen twill <input type="checkbox"/> A	+\$0
LBJ	graphite twill <input type="checkbox"/> A	+\$0
LBQ	white twill <input type="checkbox"/> A	+\$0
LM	mahogany <input type="checkbox"/> A	+\$0
LU	soft white <input type="checkbox"/> A	+\$0
MT	medium tone <input type="checkbox"/> A	+\$0
SG	slate grey <input type="checkbox"/> A	+\$0
WA	wheat <input type="checkbox"/> A	+\$0
WL	sandstone <input type="checkbox"/> A	+\$0
WN	warm grey neutral <input type="checkbox"/> A	+\$0

Meridian® Storage Surround
Support Legs

FSLR-
FSL-

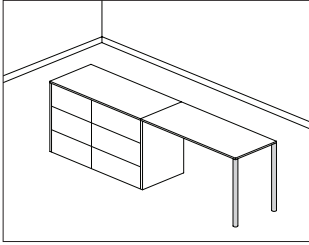

Product Information

Description

This metal leg attaches to a surround top in lieu of a surround end panel. Each leg has an adjustable glide with 1½" of height adjustment. Specified and shipped as a pair (2).

Surround legs are designed to align with the following case, base, and top specifications:

- 37—aligns with 35¼" case height with 2¼" base and no top
- 38—aligns with 35¼" case height with 2¼" base and 1¼" top
- 41—aligns with 39⅜" case height with 2¼" base and no top
- 42—aligns with 39⅜" case height with 2¼" base and 1¼" top

Notes

Legs are used to support 1 end of file surround top (FSTL-, FSLV-), and leg height matches height of file surround end panel (FSEL-, FSEV-).

Meridian® File Surrounds

Dimensions

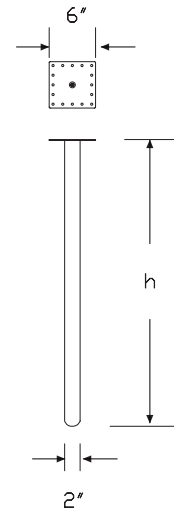

round

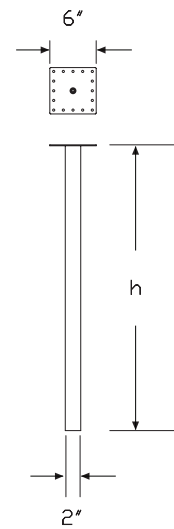

square

Meridian® Storage Surround

Support Legs *continued*

Specification Information

Step 1.

FSL

Step 2. Leg Style

R- round

S- square

Step 3. Height

37 37.5" high

38 38.75" high

41 41.625" high

42 42.875" high

Prices for Steps 1-3.

FSLR-	37	\$299
	38	\$299
	41	\$325
	42	\$325

FSLS-	37	\$402
	38	\$402
	41	\$423
	42	\$423

Step 4. Paint/Steel Type

SS smooth paint on smooth steel +\$0

XS textured paint on smooth steel +\$0

Step 5. Surface Finish

Bright Sand Texture Paint

For textured paint on smooth steel (XS)

91 white +\$0

G1 graphite +\$0

Metallic Paint

For smooth paint on smooth steel (SS)

MS metallic silver +\$10

Front-to-Back Filing Rail,
Meridian® Stackable™ Lateral File

9P001
9P002
9P361
9P362

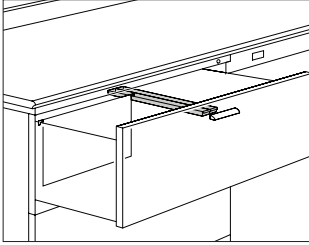

Product Information

Description

This filing rail holds letter-size hanging folders for front-to-back filing. The 16" rail is used in an 18"-deep Meridian® lateral file drawer. The 18" rail is used in the file drawer of a Meridian Stackable Storage™ cabinet bottom module, 20"-deep Meridian lateral file, or Meridian lateral storage tower.

Dimensions

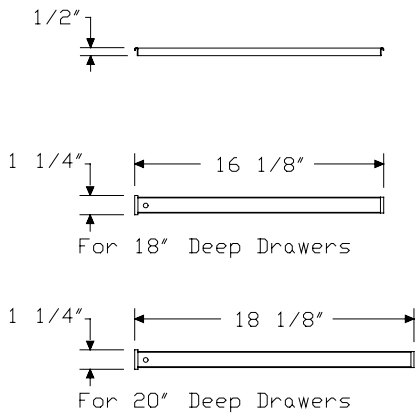

Specification Information

Step 1.

9P

Step 2. Width

00 for 30"- or 42"-wide drawers
36 for 36"-wide drawers

Step 3. Depth

18 18" deep
20 20" deep

Prices for Steps 1-3.

9P0018	\$27
9P0020	\$27
9P3618	\$27
9P3620	\$27

Side-to-Side Filing Rail, Meridian® Stackable™ Lateral File

9R124
9R130
9R136
9R142
9R224
9R230
9R236
9R242

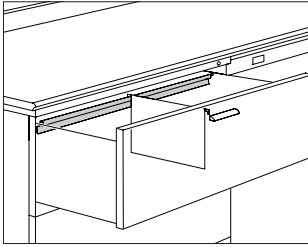

Product Information

Description

This filing rail holds letter- or legal-size hanging folders for side-to-side filing. The 21"-wide rail is used in the file drawer of a 24"-wide Meridian® Stackable Storage™ cabinet bottom module. The 27"-wide rail is used in the file drawer of a 30"-wide Meridian Stackable Storage cabinet bottom module, Meridian lateral file, or Meridian lateral storage tower. The 33"-wide rail is used in the file drawer of a 36"-wide Meridian lateral file. The 39"-wide rail is used in the file drawer of a 42"-wide Meridian lateral file.

Dimensions

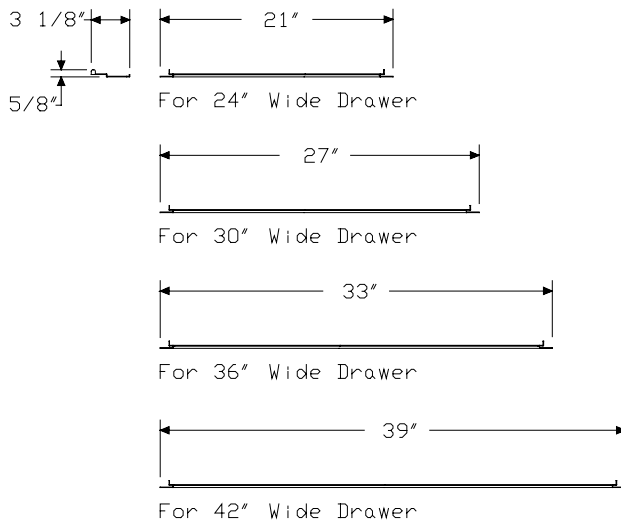

Specification Information

Step 1.

9R

Step 2. Quantity

1 1 filing rail
2 2 filing rails

Step 3. Width

2400 for 24"-wide drawers
3000 for 30"-wide drawers
3600 for 36"-wide drawers
4200 for 42"-wide drawers

Prices for Steps 1-3.

9R12400	\$20
9R13000	\$20
9R13600	\$20
9R14200	\$20
9R22400	\$40
9R23000	\$40
9R23600	\$40
9R24200	\$40

Movable Divider, Meridian®,
 Quadrant® or Tu®

9M100
 9M300

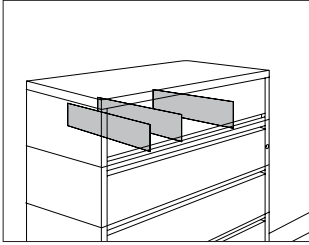

Product Information

Description

This adjustable metal divider fits into slots of an 18" or 20"-deep Meridian® Stackable™ lateral file drawer. The 18"-deep divider also fits into a pullout shelf's slots on a Tu® or Quadrant® 5-high lateral file. Finish is black umber.

Dimensions

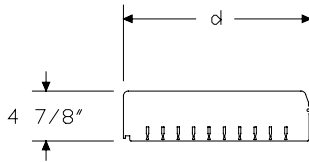

Specification Information

Step 1.

9M

Step 2. Quantity

- 100** 1 divider
- 300** 3 dividers

Step 3. Depth

- 18** for Meridian® 18"-deep Stackable™ lateral file modules or Quadrant® 20" deep flipper door with pullout shelf
- 20** for Meridian® 20" deep Stackable™ lateral file modules

Prices for Steps 1-3.

9M100	18	\$14
	20	\$14
9M300	18	\$34
	20	\$34

File Drawer Organizer

LG901

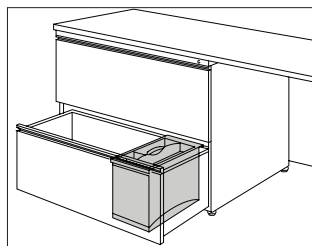

Product Information

Description

This 2-sectioned organizer fits into any file drawer arranged for letter-size filing. The removable top section stores computer disks and other small items. The bottom section stores larger items or can be divided into 3 compartments; it includes 2 vertical dividers. Finish is black umber.

Dimensions

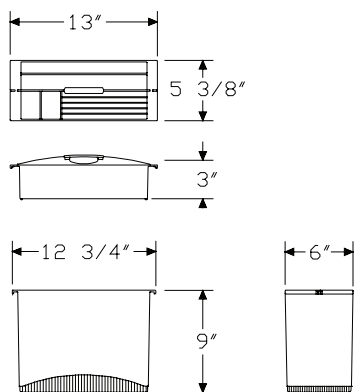

Specification Information

Step 1.

LG901

\$77

EnhancedAccess™ Pull

EAP-L

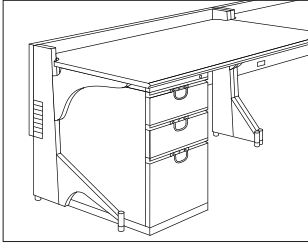

Product Information

Description

This plastic loop-style pull slides into the standard pull or Tu® W-pull on a pedestal or lateral file drawer. It makes the drawer easier to open. Package contains 1 pull and attachment hardware.

Dimensions

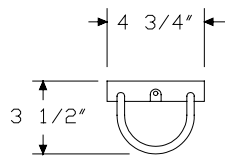

Specification Information

Step 1.

EAP-

Step 2. Pull Style

L loop

Prices for Steps 1-2.

EAP-L \$54

Step 3. Finish

BU	black umber	+\$0
HF	inner tone light	+\$0
MT	medium tone	+\$0

Label Holders-Snap In and Adhesive

9LH5H
9LH7H

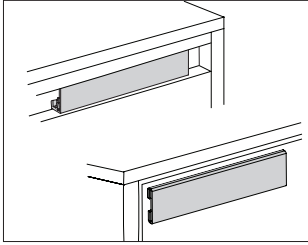

Product Information

Description

These label holders snap in place for standard pull file drawers or attach with adhesive onto drawers with other pull styles. Package contains 25 of the specified style. Labels included.

Dimensions

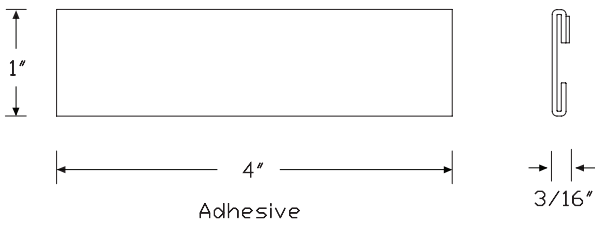
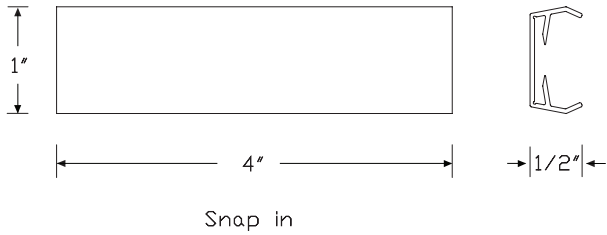

Specification Information

Step 1.

9LH A

Step 2. Style

5HV snap in A

7HT adhesive A

Prices for Steps 1-2.

9LH5HV	\$19
9LH7HT	\$17

Index by Product Name

Meridian® Lateral Files	
Arc-Pull Freestanding Lateral File	page(s) 30
Bar-Pull Freestanding Lateral File	36
Bevel-Pull Freestanding Lateral File	42
Bevel-Pull Mobile Lateral File	64
Ellipse-Pull Freestanding Lateral File	47
EnhancedAccess™ Pull	78
File Drawer Organizer	77
Front-to-Back Filing Rail, Meridian® Stackable™ Lateral File	74
Label Holders-Snap In and Adhesive	79
Meridian® File Top	69
Meridian® Storage Surround Support Legs	72
Movable Divider, Meridian®, Quadrant® or Tu®	76
Retrofit Cushion Top	57
Side-to-Side Filing Rail, Meridian® Stackable™ Lateral File	75
Sloped-Pull Freestanding Lateral File	52
Standard-Pull Freestanding Lateral File	25
Standard-Pull Mobile Lateral File	59



Index by Product Number

2A-30	Arc-Pull Freestanding Lateral File	page(s) 30	TC1-3	Retrofit Cushion Top	57
2A-36			TC1-4		
2A-42			TC2-3		
2D-30			TC2-4		
2D-36			TPL-0	Meridian® File Top	69
2D-42			TPL-1		
2J-30	Ellipse-Pull Freestanding Lateral File	47			
2J-36					
2J-42					
2KP-3	Bar-Pull Freestanding Lateral File	36			
2KP-4					
2KV-3					
2KV-4					
9LH5H	Label Holders-Snap In and Adhesive	79			
9LH7H					
9M100	Movable Divider, Meridian®, Quadrant® or Tu®	76			
9M300					
9P001	Front-to-Back Filing Rail, Meridian® Stackable™ Lateral File	74			
9P002					
9P361					
9P362					
9R124	Side-to-Side Filing Rail, Meridian® Stackable™ Lateral File	75			
9R130					
9R136					
9R142					
9R224					
9R230					
9R236					
9R242					
24-30	Bevel-Pull Freestanding Lateral File	42			
24-36					
24-42					
26-30	Standard-Pull Freestanding Lateral File	25			
26-36					
26-42					
29P-3	Sloped-Pull Freestanding Lateral File	52			
29P-4					
29V-3					
29V-4					
EAP-L	EnhancedAccess™ Pull	78			
FSLR-	Meridian® Storage Surround Support Legs	72			
FSLS-					
LG901	File Drawer Organizer	77			
M24-3	Bevel-Pull Mobile Lateral File	64			
M24-4					
M26-3	Standard-Pull Mobile Lateral File	59			
M26-4					



20-Day or Less/Assigned Lead-Time Order Information

20-Day or Less and Assigned Lead-Time Programs

20-day or less and assigned lead-time products are designed for established Herman Miller dealers with pre-approved credit.

Products are distributed from multiple manufacturing facilities across the United States. All products and options not designated by an Assigned Lead-Time icon **A** will ship in 20 business days or less after being acknowledged by Herman Miller. Products and options designated by an **A** are on the assigned lead-time program and will ship in 20 days, less than 20 days, or more than 20 days from order acknowledgement.

Ordering Procedure

Please place orders through Order Manager. If this is not available to you, place orders through mail or fax. Verbal purchase orders will not be accepted.

Order Entry fax number for Passage®, 5000 Series, and Meridian® Filing and Storage: (616) 846 9236.

Order Entry fax number for all other products:
(616) 654 3085.

For more information, contact your Customer Care representative at:
(866) 854 3048 EXT 3400.

Shipments and Delivery

Per Herman Miller Terms and Conditions.

Changes and Cancellation

Per Herman Miller Terms and Conditions.



Keyed-Alike Information

Keyed-Alike Locks

All components with locks may be specified keyed alike. Products with keyed-alike locks will be shipped with lock chassis installed.

Installation of lock cylinders will be on-site according to instructions provided. Herman Miller, Inc., will not be responsible for lock cylinder installation.

When specifying product keyed-alike, include separate lines on your order for the lock cylinders.

For Action Office®, Ethospace®, Passage®, Quadrant®, Resolve®, and Supplemental products, list cylinder part number and key number (232092-XXX); select a key number (or numbers) between 226 and 427, excluding numbers 408 and 412.

The following products require a different lock cylinder part number. Specify UKY001-XXX for these products only; select a key number (or numbers) between 226 and 427, excluding numbers 408 and 412.

- A3013.
- A3053.
- G5180.
- G5181.
- G5280.

The keys provided in 232092-XXX and UKY001-XXX kits work with either cylinder type, provided the key numbers match.

For Tu® Storage, Canvas Office Landscape®, 5000 Series, and Meridian® Storage, see the following charts.

Keyed-alike locks are field installed.

To order keyed-alike locks for Action Office® Series 1 and 2 door panels, please contact Customer Care.

A master key can be used to open any lock on an attached or freestanding component. In addition, a removal key or lock change tool is required to remove lock plugs. Customers interested in ordering master keys, removal keys, or lock change tools should contact Customer Care.

For Canvas overhead and lower storage units, specify as follows:

Specification Code	Part Number	Color	Lock Series
KA	1B2JK7-XXX ¹	chrome	UM series 226-427

For Meridian Storage, Tu Storage, and 5000 Series desk components with pedestals, specify as follows:

Specification Code	Key Number	Color	Lock Series
KA	232092-XXX ¹	black	UM series 226-427
KA	1B2JK7-XXX ¹	chrome	UM series 226-427

For 5000 Series flipper door unit with bezel or credenza storage cabinet with bezel, specify as follows:

Specification Code	Key Number	Color	Lock Series
KA	232092-XXX ¹	black	UM series 226-427

Key Number:

XXX¹ = a key number between 226 and 427 (excluding 408 and 412)



Vary Easy Program

Program Overview

Vary Easy is a program designed to help dealers specify standard products with a larger breadth of options. For example, depending on the type of product being specified, choices include additional size, finish, edge types, and cable management features. Vary Easy 3D, specIT, and third-party text-based specification packages support the Vary Easy program. Vary Easy 3D enables designers to create a 3D image, CAD symbols, and a price book page. A Vary Easy product number is assigned for each product as the user selects specific options. Once the product is completely specified, the order can be submitted via Kiosk's Order Manager or a dealer's business system.

Accessing and Specifying Vary Easy

To view the full product vocabulary, go to the Vary Easy Product Offering on Kiosk. To specify Vary Easy, go to the Vary Easy 3D website on Kiosk, specIT, or your third-party text-based specification package.

Once you've made your product line selection, continue to follow through each option and enter the specific options that represent the product you need. When the product is fully specified, Vary Easy will generate an orderable product number and instantly calculate a price.

Note: Failure to completely specify a product will cause a delay in order acknowledgements. Be sure to make a selection for all options offered.

The acknowledgement process for Vary Easy products is the same as for any standard order. Vary Easy products ship with a standardized lead time and are competitively priced.

For more information, contact your Customer Care Line at (866) 854 3048 EXT 3400.



Customer's Own Material/ Customer's Own Leather Order Information — Cushion Tops

Customer's Own Material/Customer's Own Leather

Program Overview

The Customer's Own Material (COM) and Customer's Own Leather (COL) program gives you the option of using textiles other than those listed. Herman Miller will test textiles for application to Herman Miller products and will process orders for those with approved COM/COL textiles only. COM/COL are assigned lead time textiles.

Omni lists an overview of fabrics and leathers that have been tested and indicates whether or not they were approved for application to Herman Miller products.

Specific information on the terms and conditions, testing, approval, and ordering process for COM/COL is listed below. Questions about the COM/COL program and requests for assistance may be directed to your COM representative at:

(616) 654 3400

(866) 854 3048 EXT 6543400

Customer's Own Material/Customer's Own Leather Warranty

Herman Miller does not warrant COM/COL textiles. COM/COL textiles are tested for application only; they are not tested for performance. The Herman Miller warranty does apply to the underlying products.

Suppliers of COM/COL textiles are responsible for color consistency within commercial tolerances, UV stability, and resistance to soiling and perspiration.

Customer's Own Material/Customer's Own Leather Pricing

COM is a Category 1 fabric. There are no application charges for COM fabrics. COL is a Category 7 textile; refer to prices on specific products to determine the application charge.

Ordering and payment for COM/COL textile yardage are the responsibility of the customer and the textile supplier.

If desired, Herman Miller will purchase COM textiles directly from True Textiles, C.F. Stinson, Luna Textiles, Maharam, and Momentum Textiles to simplify ordering and shipment. For this service, refer to the Supplier Connection program.

Application Note

Herman Miller does not guarantee that Customer's Own Material (COM) fabric patterns will align across panels/tiles or from one screen to the next. We also do not guarantee that COM fabric designs will be positioned consistently in the same location across several panels, tiles, or screens.

Textile Approval

1. Select a COM/COL textile.
2. If your textile is not listed on Omni, obtain a test number from a COM representative at (616) 654 3400. You can also submit your request within Omni. Please have the following information ready before calling: textile name, number, pattern, and the product you will apply it to.
3. Herman Miller will notify you of approval or disapproval within 4 days from receipt of the test yardage.

Customer's Own Material/ Customer's Own Leather Order Information — Cushion Tops

continued

Ordering Products with COM/COL

1. Refer to the specific products to determine the yardage required for COM/COL textiles.
2. If your textile is not listed on Omni, call a COM representative at (616) 654 3400 or (866) 854 3048 EXT 6543400. The representative will assign an identification number for your textile (ID#) and will verify yardage requirements for your order. Yardage requirements are based on directional, 54"-wide textiles. Additional yardage may be needed due to the unique characteristics of a textile.
3. Enter your order on Order Manager in Omni.
4. Upon receipt of your purchase order, Herman Miller will send you a PO acknowledgment.
5. Arrangements must be made for the textiles to be shipped from the supplier to Herman Miller for application to the seating products. See Omni for shipping procedures and current shipping addresses or contact a COM representative at (616) 654 3400 or (866) 854 3048 EXT 6543400.

Products will be scheduled for production when COM/COL textiles are received at Herman Miller. Standard lead times in effect at that time will apply.

Note: If textiles are to be purchased directly by Herman Miller through the Supplier Connection program, Herman Miller will handle the ordering and shipping process and will schedule your order for production upon receipt of your purchase order (dependent on textile availability). Refer to the Supplier Connection program for more information.

Supplier Connection

Program Overview

The Supplier Connection program is a service offered by Herman Miller to purchase approved COM textiles directly from True Textiles, C.F. Stinson, Luna Textiles, Maharam, and Momentum Textiles. When you select a textile through this program, Herman Miller will facilitate the ordering, scheduling, and shipment of the textile directly with the supplier.

Suppliers included in the Supplier Connection program keep an active inventory of textiles that are pre-approved for application to Herman Miller products. Pre-approval applies only to the suitability of a textile for manufacturing and application to a Herman Miller product. Omni provides an overview of fabrics that have been tested and indicates whether or not they were approved for application to Herman Miller products.

Specific information on the terms and conditions, testing, approval, and ordering process for the Supplier Connection program is listed below. Questions and requests for assistance may be directed to your COM representative at:

(616) 654 3400
(866) 854 3048 EXT 6543400

Supplier Connection Warranty

Textiles purchased by Herman Miller through the Supplier Connection program are COM and are not warranted by Herman Miller. COM textiles are tested for application only; they are not tested for performance. The Herman Miller warranty does apply to the underlying products.

Suppliers of COM textiles are responsible for color consistency within commercial tolerances, UV stability, and resistance to soiling and perspiration.

Customer's Own Material/ Customer's Own Leather Order Information — Cushion Tops

continued

Supplier Connection Pricing

Textiles purchased by Herman Miller through the Supplier Connection program are COM. COM is a Category 1 fabric. There are no application charges for COM fabrics.

Payment for textiles purchased by Herman Miller through the Supplier Connection program is the responsibility of the customer or dealer. Herman Miller will invoice the order at the supplier's prices published at the time of the order.

Textile Approval

1. Refer to Omni to identify the approval status of the textile. If your textile is not listed, contact the COM Department to request testing for application to Herman Miller products.
2. Herman Miller will notify you of approval or disapproval in approximately 4 days from receipt of the test yardage. If the textile is approved, it will be assigned a COM identification number.

Ordering Products with Supplier Connection COM

1. Identify and include the following information on your purchase order:
 - Product number and option
 - Herman Miller's COM identification number
2. Enter your order on Order Manager in Omni.
3. Upon receipt of the purchase order, Herman Miller will process your order and send you a PO acknowledgment. Herman Miller will determine the yardage required to produce your product and will order and schedule for delivery the required textile. Standard lead times in effect at the time the textile is allocated at the supplier will apply to products ordered through this program.



Proprietary Textiles Application Chart — Seating

• Available

[A] Assigned lead-time textile.

See following page for exception notes.

[N] Non-woven textile.

	Aeron® Chairs	Mirra® 2 Chairs/Stools	Celle® Chairs	Embody® Chairs	Sayl® Work Chairs/Stools	Sayl Side Chairs	Setu® Chairs/Stools	Setu Lounge Chair/Ottoman	Verus™ Work Chairs/Stools Back	Verus Work Chairs/Stools Seat	Verus Side Chairs Back	Verus Side Chairs Seat	Ergon 3® Chairs	Equa 2 Fully Upholstered Chairs/Stools	Equa 2 Split-Pad Upholstered Chairs/Stools	Aside® Chairs	Caper® Chairs/Stools	Keyn Chair Group Back	Keyn Chair Group Seat	Locale® Bench Cushion	Public® Office Landscape Back	Public Office Landscape Seat	Swoop™ Lounge Seating - Fully Upholstered	Swoop Lounge Seating - Plywood	Cushion Tops	Workspaces	
Price Category 1																											
COM Customer's Own Material [A]			14		1	1								1	1	1	1			1	1		1	1	1	1	1
231__ 8Z Pellicle®	•																										
1A7__ AireWeave 2		•																									
3P__ ColorGuard [N]			15		•	22	•	•	•	•	•	•	•	2	3	8		•	•	•			•	•	•	•	•
8T__ Crossing			•				•	•						•	•	•				•			•	•	•	•	•
6V__ Flexnet™																	•										
95__ Gem			14				•	•						•	•	•				•			•	•	•	•	•
65__ Interweave									•		•																
4W__ Lyris 2™							•	•			•																
1MN__ Monologue			14		24	22	•	•	•	•	•	•	•					•	•	•		•	•	•	•	•	•
3D__ Pellicle® Classic (3V__)																											
1WS__ Whisper			14		24	•	•	•	•	•	•	•	•	•	•	•		•	•	•		•	•	•	•	•	•
Price Category 2																											
92__ Crepe			•		•	•	•	•	•	•	•	•	•	•	•	•		•	•	•			•	•	•	•	•
1LM__ Loom			14		•	•			•	•	•	•		•				•	•	•		•	•	•	•	•	•
1MV__ Marvel						21	22												•								•
1HA__ Medley			14		•	•	22		•	•	•	•	•	•	•	•		•	•	•	•	•	•	•	•	•	•
3A__ Moiré			14		•	•	•	•	•	•	•	•	•	•	•	•		•	•	•		•	•	•	•	•	•
30__ Rhythm			•	23	•	•			•	•	•	•		•	•	•		•	•	•		•	•	•	•	•	•
1RV__ Rivet			14						•	•	•	•						•	•	•		•	•	•	•	•	•
8R__ Twist			•		•	•	•	•	•	•	•	•		•	•	•		•	•	•		•	•	•	•	•	•
Price Category 3																											
70__ Bento					•	•	•	•	•	•	•	•	2	•	•	8		•									•
8M__ Latitude™			23		•	•									3								•	•			
8U__ Stitches			•		•	•	•	•	•	•	•	•	•	•	•	•		•	•			•	•	•	•	•	•
Price Category 4																											
7Y__ Bingo [N]							•	•	•	•	•	•	2		3	8		•	•	•							•
213__ Mercer			14		•	21	22		•	•	•	•						•	•			•	•	•	•	•	•
1A9__ Network																				•							
6J__ Plateau													•	•	•	•											•
6S__ Quilty			14		•	•			•	•	•	•						•	•	•			•	•	•	•	•
8Y__ Spools			14		21	•			•	•	•	•	•	•	•	•		•	•	•		•	•	•	•	•	•
22P__ Strata					•	•	•		•	•	•	•				•		•	•	•	•	•	•	•	•	•	•
Price Category 5																											
No fabrics available at this time																											
Price Category 6																											
35__ Balance					•		•																				
Price Category 7																											
COL Customer's Own Leather [A]	1		14										1	1	1	8										1	
Price Category 8																											
No fabrics available at this time																											
Price Category 9																											
21__ Leather	23		14											•	•	8								•	•		

Proprietary Textiles Application Chart — Seating

continued

• Available

[A] Assigned lead-time textile.

See below for exception notes.

[N] Non-woven textile.

Fire-Retardant Chairs/Fabrics

	Mirra® 2 Chairs/Stools with Butterfly Back™	Celle® Chairs	Embody® Chairs	Sayl® Work Chairs/Stools	Sayl Side Chairs	Setu® Chairs/Stools	Setu Lounge Chair/Ottoman	Ergon 3® Chairs	Equa 2® Fully Upholstered Chairs/Stools	Equa 2 Split-Pad Upholstered Chairs/Stools	Aside® Chairs	Caper® Chairs/Stools	Swoop™ Lounge Seating - Fully Upholstered
Price Category 1													
COM Customers Own Material [A]							1	1	1	1			
1A7__ AireWeave™ 2	•												
3P__ ColorGuard [N]		15	24	22			2		3	8			•
8T__ Crossing		14				•	•	•	•	•			•
6V__ Flexnet™												•	
95__ Gem		14				•	•	•	•	•			•
4W__ Lyris 2™					18	•							
Price Category 2													
92__ Crepe		14	•	•				•	•	•			•
3A__ Moiré		14	•	•	•	•	•	•	•	•			
30__ Rhythm		14	24	•						8			•
8R__ Twist		14	•	•	•	•	•		•	8			•
Price Category 3													
70__ Bento				•	•	•	•	2			8		•
8M__ Latitude™		•	•	•									
8U__ Stitches		14	•	•	•	•	•	•	•	•			•
Price Category 4													
6J__ Plateau											•		
6S__ QUILTY		14	•	•									•
Price Category 5													
No fabrics available at this time													
Price Category 6													
35__ BALANCE			17										
Price Category 9													
21__ Leather		14									8		

All foam and Proprietary Textiles on HermanMiller seating comply with California TB 117-2013.

Application Note: Herman Miller cannot guarantee material/pattern alignment in adjacent products. For example, a fabric pattern may not align from one pedestal cushion top to the next, or from one chair to the next.

1 Refer to price book appendices and Kiosk for COM/COL information.

2 Available on all Ergon 3 chairs except for fabric back (FB) option.

3 Available on A-and B-size Equa 2 split-pad upholstered chairs.

8 Only available on non-upholstered outer back (PB) option.

14 Available on Celle UC (upholstered seat) and HC (upholstered seat with protective edge) chairs.

15 Available on Celle HC (upholstered seat with protective edge) Chairs.

17 Only available in 3512 Carbon and 3513 Black.

18 Only available in 4W26 Slate Grey, 4W30 Java and 4W31 Graphite.

21 Not available on Sayl upholstered back work chairs.

22 Not available on Sayl side chairs with upholstered backs.

23 Available in select colors. Refer to "Proprietary Textile Colors - Seating" for color offering.

24 Not available on Sayl upholstered High-Back Work Chairs.

Proprietary Textile Colors — Seating

Price Category 1

Customer's Own Material
See Order Information in
Appendices.
Assigned lead-time textile. A

8Z Pellicle®
For New Aeron® Chairs
56% elastomeric
44% polyester
23101 Mineral
23102 Carbon
23103 Graphite

AireWeave™ 2
For Mirra® 2 Chairs
67% elastomeric
33% antimony-free polyester
1A701 Alpine
1A702 Slate Grey
1A703 Graphite
1A704 Lime Green
1A705 Cappuccino
1A706 Urban Orange
1A707 Dark Turquoise
1A708 Twilight

ColorGuard
54" wide
100% vinyl
3P01 Grey
3P02 Navy
3P03 Spruce A
3P08 Blueberry A
3P12 Black Plum A
3P14 Black
3P19 Slate
3P31 Horizon Blue A
3P33 Pumice
3P54 Candy Apple A
3P72 Allspice A
3P96 Manzanita A
3P97 Fudge A
3PB2 Sea Grass A
3PB5 Vizcaya Palm A
3PB9 Neptune A
3PC7 Bucksuede A
3PD4 Otter A

A Assigned lead-time color.

Crossing
54" wide
86% antimony-free polyester
14% polyester
8T03 Wicker
8T04 Porcelain
8T05 Warm Grey
8T06 Sepia
8T07 Pumpkin
8T08 Copper
8T09 Cranberry
8T10 Tomato
8T11 Mulberry
8T12 Plum
8T13 Green Apple
8T14 Loden
8T15 Spruce
8T16 Periwinkle
8T17 Cerulean
8T18 Indigo
8T19 Shale
8T20 Brownstone
8T21 Bark
8T22 Tin
8T23 Graphite
8T24 Black

Flexnet™
For Caper® Chairs
69% elastomeric
31% polyester
6V01 Black
6V02 Silver Grey

Gem
54" wide
100% antimony-free polyester
9501 Sesame
9502 Tangerine
9503 Red
9504 Red Violet
9505 Mulberry
9506 Java
9507 Twilight
9508 Bayou
9509 Iris
9510 Berry Blue
9511 Aqua Green
9512 Green Apple
9513 Spruce
9514 Black
9515 Slate Grey
9516 Fog

Interweave
For Verus™ Chairs
71% elastomeric
29% polyester
6504 Pewter
6505 Charcoal
6506 Black

Lyris 2™
For Setu® Chairs
74% elastomeric
26% polyester
4W21 Alpine
4W22 Mango
4W23 Chartreuse
4W25 Berry Blue
4W26 Slate Grey
4W28 Chino
4W29 Rattan
4W30 Java
4W31 Graphite

Proprietary Textile Colors — Seating

continued

Price Category 1

continued

Monologue

54" wide	
56% recycled polyester	
44% polyester	
1MN01	Linen
1MN02	Alabaster
1MN03	Truffle
1MN04	Folkstone
1MN05	Silver Pine
1MN06	Slate
1MN07	Seed
1MN08	Yellow Oxide
1MN09	Persimmon
1MN10	Tundra
1MN11	Meadow
1MN12	Blue Sky
1MN13	Blue Spruce
1MN14	Deep Sea

Whisper

54" wide	
73% recycled polyester	
27% polyester	
1WS01	Sand Dollar
1WS02	Pebble
1WS03	Silver Birch
1WS04	Iceberg
1WS05	Silver Pine
1WS06	Carbon
1WS07	Cumin
1WS08	Adobe
1WS09	Strawberry
1WS10	Blush
1WS11	Eggplant
1WS12	Willow
1WS13	Sea Grass
1WS14	Pool
1WS15	Blueberry

Crepe

54" wide	
100% recycled polyester	
9201	Licorice
9203	Smoke
9207	Cherry
9209	Claret
9212	Raisin
9218	Aquamarine
9223	Cadet
9241	Beachglass
9243	Midnight
9244	Artichoke
9248	Warm White
9249	Stone
9250	Earth
9251	Fog
9252	Slate Grey
9253	Yellow Dark
9254	Coral
9255	Blush Grey
9256	Wild Berry
9257	Clover
9258	Caribbean
9259	Cerulean
9260	Brownstone
9261	Shale
9262	Graphite
9263	Tomato
9264	Green Apple

Loom

54" wide	
100% polyester	
1LM01	Linen
1LM02	Brown Sugar and Spice
1LM03	Brick and Mortar
1LM04	Salt and Pepper
1LM05	Black
1LM06	Lemongrass
1LM07	Poppy
1LM08	Wild Berry
1LM09	Loden
1LM10	Jade
1LM11	Deep Sea

Price Category 2

Medley

54" wide	
100% polyester	
1HA01	Stone
1HA02	Trail
1HA03	Charcoal
1HA04	Cinder
1HA05	Citrus
1HA06	Papaya
1HA07	Chutney
1HA08	Tundra
1HA09	Feather Grey
1HA10	Chartreuse
1HA11	Loden
1HA12	Peacock
1HA13	Bayou
1HA14	Blue Grotto
1HA15	Blueberry
1HA22	Khaki
1HA23	Pewter
1HA24	Yellow Oxide
1HA25	Vintage Rose
1HA26	Raspberry
1HA27	Acai Berry

Moiré

54" wide	
100% recycled polyester	
3A01	Concrete
3A02	Biscotti
3A03	Rattan
3A04	Chambray
3A05	Fern
3A08	Violet
3A09	Zin
3A10	Curry
3A11	Spice
3A12	Cork

Rhythm

54" wide	
100% polyester	
3001	Kiwi Green *
3002	Green Apple
3003	Peacock
3004	Bayou *
3005	Berry Blue
3006	Iris
3007	Twilight
3008	Pumpkin *
3009	Poppy *
3010	Molasses
3011	Mulberry
3012	Khaki *
3013	Mink
3014	Black
3015	Charcoal

* Colors not available on Embody Chair

Rivet

54" wide	
100% recycled polyester	
1RV01	Twig
1RV02	Deep Clay
1RV03	Woodrose
1RV04	Otter
1RV05	Hemlock
1RV06	Olive
1RV07	Lagoon
1RV08	Deep Sea
1RV09	Charcoal
1RV10	Grey Brindle

Price category 2 continued on next page

Proprietary Textile Colors — Seating

continued

Price Category 2

continued

Twist	
54" wide	
80% antimony-free polyester	
13% recycled polyester	
7% polyester	
8R05	Wicker
8R10	Poppy
8R14	Tin
8R15	Shale
8R16	Graphite
8R17	Birch
8R18	Sepia
8R22	Blueberry
8R23	Green Apple
8R26	Gunmetal
8R27	Cinder
8R28	Citrus
8R29	Pekoe
8R30	Tangerine
8R31	Red Plum
8R32	Wisteria
8R33	Forest
8R34	Jade Dark
8R35	Waterfall
8R36	Midnight Blue
8R37	Carbon Dark

Price Category 3

Bento	
54" wide	
100% antimony-free polyester	
7001	Frost
7002	Linen
7003	Khaki
7004	Truffle
7005	Grey Black
7006	Pumpkin
7007	Cranberry
7008	Everglade
7009	Cobalt

Latitude™	
61" wide	
100% polyester	
8M01	Graphite
8M02	Shadow
8M10	Alpine
8M17	Black
8M21	Slate Grey
8M22	Lime Green
8M23	French Press
8M24	Urban Orange
8M25	Dark Turquoise
8M26	Twilight

Stitches	
54" wide	
54% polyester	
46% recycled polyester	
8U02	Rye
8U03	Khaki
8U04	Honey
8U05	Cattail
8U08	Cool Grey
8U09	Slate Blue
8U11	Evening Blue
8U12	Charcoal
8U13	Kiwi Green
8U16	Cocoa
8U17	Seed

Price Category 4

Bingo	
54" wide	
100% PVC-free polyurethane	
Resilience® finish	
7Y01	Oyster
7Y02	Natural
7Y03	Cashew
7Y05	Rattan
7Y06	Root
7Y07	Woodland
7Y10	Allspice
7Y11	Canyon
7Y17	Seed
7Y18	Mushroom
7Y19	Blue Grey
7Y21	Black
7Y22	Mint
7Y23	Seaport
7Y24	Evening Blue
7Y26	Kiwi Green
7Y27	Celadon
7Y29	Pesto

Mercer	
54" wide	
50% solution dyed recycled nylon	
50% solution dyed nylon	
BLOCKaide	
21301	Stone
21303	Cayenne
21305	Pesto
21306	Teal Blue
21307	Ultramarine
21310	Charcoal

Network	
For Public Office Landscape®	
sectional back/social chair.	
knit to size	
100% polyester	
1A901	Warm White
1A902	Fog
1A903	Red
1A904	Wildberry
1A905	Green Apple
1A906	Twilight
1A907	Graphite

Plateau	
knit to size	
100% polyester	
6J01	Feather Grey
6J02	Trail
6J06	Twig
6J08	Sagebrush
6J09	Winter Berry
6J10	Thunder
6J11	Blueberry
6J12	Rosemary
6J14	Black

Quilty	
56" wide	
100% antimony-free polyester	
GreenShield	
6S03	Khaki
6S04	Straw
6S07	Brick
6S10	Mink
6S11	Green Apple
6S13	Indigo
6S14	Zinc
6S15	Slate
6S16	Beachwood
6S17	Paprika
6S18	Plum
6S19	Juniper
6S20	Grey Black

Price category 4 continued on next page

Proprietary Textile Colors — Seating

continued

Price Category 4

continued

Spools

54" wide
51% recycled polyester
49% polyester
Crypton® Green

8Y03	Trail
8Y05	Copper
8Y08	Bluegrass
8Y09	Lagoon
8Y11	Beachglass
8Y12	Marsh
8Y13	Bud

Strata

54" wide
50% solution dyed recycled nylon
50% solution dyed nylon
BLOCKaide

22P04	Pesto
22P05	Peacock
22P06	Blue Jay
22P07	Blueberry
22P09	Mango
22P10	Paprika
22P12	Wheat
22P13	Brownstone
22P14	Bayou

Price Category 5

No fabrics available at this time.

Price Category 6

Balance

100% polyester

3506	Green Apple
3507	Blue Moon
3509	Berry Blue
3510	Iris
3512	Carbon
3513	Black

Price Category 7

Customer's Own Leather

See Order Information in Appendices. Assigned lead-time textile. [A](#)

Proprietary Textile Colors — Seating

continued

Price Category 8

No fabrics available at this time.

Price Category 9

Leather

approx. 50 sq. ft. per hide
100% leather

2101	Ivory
2109	Black *
2110	Smoke
2111	Graphite
2112	Khaki
2113	Rattan
2114	Truffle
2115	Alpine
2116	Haze
2117	Sable Grey
2118	Dark Mineral **
2119	Dark Carbon ***
2120	Cranberry
2121	Deep Sea

* Armpad color available on Aeron® Chair, Graphite.

** Armpad color available on Aeron Chair, Mineral.

*** Armpad color available on Aeron Chair, Carbon.



Maharam Application Chart — Seating

- Available

Maharam textiles are on assigned lead times. A

[N] Non-woven textile.

	Mirra® Chairs/Stools	Celle® Chairs	Sayl® Work Chairs	Sayl Side Chairs	Setu® Chairs	Setu Lounge Chair/Ottoman	Verus™ Work Chairs/Stools Back	Verus Work Chairs/Stools Seat	Verus Side Chairs Back	Verus Side Chairs Seat	Ergon 3® Chairs	Equa 2® Fully Upholstered Chairs/Stools	Equa 2 Split-Pad Upholstered Chairs/Stools	Ambi® Work Chairs	Aside® Chairs	Cape® Chairs	Keyn Chair Group Back	Keyn Chair Group Seat	Swoop™ Lounge Seating - Fully Upholstered	Swoop Lounge Seating - Plywood	Cushion Tops	Workspaces
Price Category 1-2	No fabrics available at this time.																					
Price Category 3	No fabrics available at this time.																					
Price Category 4-9	No fabrics available at this time.																					
Price Category A	No fabrics available at this time.																					
Price Category B	No fabrics available at this time.																					
TI__ Messenger - Maharam *	14	•	•	•	•	•	•	•	•	•	•	•	•	•	•	•	•	•	•	•	•	•
Price Category C	No fabrics available at this time.																					
Z27__ Manner - Maharam	14	•	•				•		•	•	•	•		•			•	•	•	•	•	•
Z3__ Metric - Maharam	14	•	•				•		•	•	•	•		•			•	•	•	•	•	•
Price Category D	No fabrics available at this time.																					
Price Category E	No fabrics available at this time.																					
Z32__ Skein - Maharam	14	16	16	•										•			•	•	•	•	•	•
Price Category F	No fabrics available at this time.																					
Z33__ Strum - Maharam [N]			16																•	•		
Price Category G	No fabrics available at this time.																					
ZC2__ Compound - Maharam [N]			16	16			•		•	•		•		8			•	•	•			
TG__ Divina Melange - Maharam	14	•	•	•			•	•	•	•	•	•	•	8			•	•	•	•	•	•
ZP3__ Pocket - Maharam																			•			•
V25__ Steelcut Trio - Maharam	14	16	•																•			•
Price Category H	No fabrics available at this time.																					
ZT__ Circles - Maharam	14	16	16																•			•
ZK__ Dot Pattern - Maharam	14	•	•	•								•		•	•				•			•
ZL__ Small Dot Pattern - Maharam	14	•	•	•	•			•		•		•		•	•				•			•
Price Category I-V	No fabrics available at this time.																					

* Available in select colors on 20-day lead-time.
Refer to "Maharam Colors - Seating" for 20-day colors.

- 8 Only available on nonupholstered outer back option (PB).
- 14 Available on Celle UC (upholstered seat) chairs.
- 16 Available on Sayl Chair seat.



Maharam Colors — Seating

Price Category 1-2	Price Category 3	Price Category 4-9	Price Category A
No fabrics available at this time.	No fabrics available at this time.	No fabrics available at this time.	No fabrics available at this time.

- Maharam textiles are on assigned lead times A unless otherwise noted.
- Fabric numbers are listed as Herman Miller fabric number/Maharam fabric number.

Maharam Colors — Seating

continued

Price Category B

Messenger — Maharam	
54" wide	
78% recycled polyester	
15% polyester	
7% nylon	
TI01/458640-001	Balsa
TI06/458640-006	Tobacco
TI07/458640-007	Shadow *
TI08/458640-008	Bayou *
TI10/458640-010	Zinc
TI24/458640-024	Poppy
TI25/458640-025	Mao
TI29/458640-029	Onyx
TI31/458640-031	Cloud *
TI38/458640-038	Depth *
TI40/458640-040	Nile
TI41/458640-041	Azure *
TI45/458640-045	Cactus *
TI46/458640-046	Ice *
TI48/458640-048	Neon *
TI50/458640-050	Hydrangea *
TI51/458640-051	Lilac
TI52/458640-052	Chestnut
TI53/458640-053	Tangelo
TI54/458640-054	Lumine *
TI58/458640-058	Snow
TI59/458640-059	Fennel

Messenger continued	
TI60/458640-060	Peridot *
TI61/458640-061	Capri
TI62/458640-062	Ultramarine
TI63/458640-063	Squall
TI66/458640-066	Cassis
TI67/458640-067	Aster
TI68/458640-068	Spice
TI69/458640-069	Cherry
TI70/458640-070	Vibrant
TI71/458640-071	Satsuma *
TI72/458640-072	Maize
TI76/458640-076	Fossil
TI77/458640-077	Ash
TI78/458640-078	Tusk
TI79/458640-079	Oyster
TI80/458640-080	Pensive
TI81/458640-081	Husk
TI82/458640-082	Fireside
TI83/458640-083	Chili
TI84/458640-084	Robust
TI85/458640-085	Beyond
TI86/458640-086	Voyage
TI87/458640-087	Everglade
TI88/458640-088	Electric

* Colors available on
20-day lead time.

Price Category C

Manner - Maharam	
54" wide	
100% recycled polyester	
Z2701/466177-001	Magic
Z2702/466177-002	Carob
Z2703/466177-003	Porpoise
Z2704/466177-004	Flint
Z2705/466177-005	Hush
Z2706/466177-006	Nuance
Z2707/466177-007	Thicket
Z2708/466177-008	Cocoa
Z2709/466177-009	Pathway
Z2710/466177-010	Cola
Z2711/466177-011	Ember
Z2712/466177-012	Wagon
Z2713/466177-013	Ablaze
Z2714/466177-014	Peel
Z2715/466177-015	Penny
Z2716/466177-016	Butterscotch
Z2717/466177-017	Harvest
Z2718/466177-018	Lioness
Z2719/466177-019	Caper
Z2720/466177-020	Parakeet
Z2721/466177-021	Greenway
Z2722/466177-022	Aquatic
Z2723/466177-023	Cottage
Z2724/466177-024	Dahlia
Z2725/466177-025	Vivid
Z2726/466177-026	Basin
Z2727/466177-027	Schooner

Metric — Maharam	
54" wide	
51% recycled polyester	
49% polyester	
Z301/466014-001	Phantom
Z302/466014-002	Fog
Z303/466014-003	Fleece
Z304/466014-004	Sourdough
Z305/466014-005	Toffee
Z306/466014-006	Driftwood
Z307/466014-007	Mineral
Z308/466014-008	Bittersweet
Z309/466014-009	Arabica
Z310/466014-010	Cerise
Z311/466014-011	Brick
Z312/466014-012	Cardinal
Z313/466014-013	Lava
Z314/466014-014	Oriole
Z315/466014-015	Cedar
Z317/466014-017	Caramel
Z318/466014-018	Pollen
Z319/466014-019	Tupelo
Z320/466014-020	Alligator
Z321/466014-021	Envy
Z322/466014-022	Bonsai
Z323/466014-023	Tar
Z324/466014-024	Anchor
Z325/466014-025	Twilight
Z326/466014-026	Admiral
Z327/466014-027	Seaport
Z328/466014-028	Scuba

- Maharam textiles are on assigned lead times **A** unless otherwise noted.
- Fabric numbers are listed as Herman Miller fabric number/Maharam fabric number.

Maharam Colors — Seating

continued

Price Category D	Price Category E	Price Category F	Price Category G
No fabrics available at this time.	Skein - Maharam 54" wide 56% recycled polyester 44% polyester Z3201/466170-001 Burrow Z3204/466170-004 Sumac Z3205/466170-005 Pomegranate Z3206/466170-006 Cavern Z3207/466170-007 Bitter Z3208/466170-008 Cinder Z3209/466170-009 Dock Z3210/466170-010 Cadet Z3211/466170-011 Marsh	Strum - Maharam 54" wide 100% polyurethane with silver-based antimicrobial Z3301/466122-001 Overcast Z3302/466122-002 Ridge Z3303/466122-003 Twilight Z3304/466122-004 Pigeon Z3305/466122-005 Char Z3306/466122-006 Cabin Z3307/466122-007 Bur Z3308/466122-008 Abalone Z3309/466122-009 Prawn Z3310/466122-010 Gourd Z3311/466122-011 Wheat Z3312/466122-012 Lemongrass	Compound - Maharam 54" wide 100% polyurethane silane-based antimicrobial ZC201/466196-001 001 ZC202/466196-002 002 ZC203/466196-003 003 ZC204/466196-004 004 ZC205/466196-005 005 ZC206/466196-006 006 ZC207/466196-007 007 ZC208/466196-008 008 ZC209/466196-009 009 ZC210/466196-010 010 ZC211/466196-011 011 ZC212/466196-012 012 ZC213/466196-013 013 ZC214/466196-014 014 ZC215/466196-015 015 ZC216/466196-016 016 ZC217/466196-017 017 ZC218/466196-018 018 ZC219/466196-019 019 Divina Melange — Maharam 59" wide 100% wool TG01/460830-120 120 TG02/460830-170 170 TG03/460830-180 180 TG04/460830-220 220 TG05/460830-260 260 TG06/460830-280 280 TG07/460830-871 871 TG08/460830-821 821 TG09/460830-771 771 TG10/460830-721 721 TG11/460830-731 731 TG12/460830-681 681 TG13/460830-631 631 TG15/460830-671 671 TG16/460830-581 581 TG17/460830-531 531 TG18/460830-521 521

Appendix: Maharam Colors — Seating

- Maharam textiles are on assigned lead times A unless otherwise noted.
- Fabric numbers are listed as Herman Miller fabric number/Maharam fabric number.

Price category G continued on next page

Maharam Colors — Seating

continued

Price Category G

continued

Divina Melange continued	
TG19/460830-571	571
TG20/460830-421	421
TG21/460830-471	471
TG22/460830-931	931
TG24/460830-971	971
TG25/460830-925	925
TG26/460830-620	620

Steelcut Trio - Maharam	
55" wide	
90% wool	
10% nylon	
V2501/465906-105	105
V2502/465906-113	113
V2503/465906-124	124
V2504/465906-133	133
V2506/465906-153	153
V2507/465906-195	195
V2508/465906-205	205
V2509/465906-213	213
V2513/465906-253	253
V2514/465906-283	283
V2518/465906-383	383
V2523/465906-453	453
V2525/465906-515	515
V2526/465906-533	533
V2527/465906-553	553
V2529/465906-645	645
V2534/465906-713	713
V2542/465906-865	865
V2543/465906-883	883
V2544/465906-915	915
V2545/465906-933	933
V2546/465906-945	945
V2547/465906-953	953
V2548/465906-965	965
V2549/465906-983	983
V2550/465906-176	176
V2551/465906-226	226

Steelcut Trio continued	
V2552/465906-236	236
V2553/465906-246	246
V2554/465906-266	266
V2555/465906-276	276
V2556/465906-336	336
V2557/465906-376	376
V2558/465906-416	416
V2559/465906-426	426
V2560/465906-436	436
V2561/465906-446	446
V2562/465906-466	466
V2563/465906-476	476
V2564/465906-506	506
V2565/465906-526	526
V2566/465906-576	576
V2567/465906-616	616
V2568/465906-636	636
V2569/465906-666	666
V2570/465906-686	686
V2571/465906-716	716
V2572/465906-746	746
V2573/465906-756	756
V2574/465906-776	776
V2575/465906-796	796
V2576/465906-806	806
V2577/465906-906	906
V2578/465906-916	916
V2579/465906-946	946
V2580/465906-966	966
V2581/465906-976	976
V2582/465906-996	996

Price Category H

Circles — Maharam	
55" wide	
70% cotton	
30% polyester	
ZT01/458310-001	Khaki
ZT02/458310-002	Fatigue
ZT03/458310-003	Document
ZT04/458310-004	Engine
ZT05/458310-005	Charcoal

Dot Pattern — Maharam	
55" wide	
71% cotton	
29% polyester	
ZK01/458300-001	Document
ZK02/458300-002	Taupe
ZK04/458300-004	Red
ZK05/458300-005	Navy

Small Dot Pattern —	
55" wide	
71% cotton	
29% polyester	
ZL01/458320-001	Document
ZL02/458320-002	Sand
ZL03/458320-003	Khaki
ZL04/458320-004	Taupe
ZL05/458320-005	Charcoal
ZL06/458320-006	Document
Reverse	
ZL07/458320-007	Red
ZL08/458320-008	Yellow
ZL09/458320-009	Green

Price Category I-V

No fabrics available at this time.

- Maharam textiles are on assigned lead times **A** unless otherwise noted.
- Fabric numbers are listed as Herman Miller fabric number/Maharam fabric number.

For more information about our products and services or to see a list of dealers, please visit us at HermanMiller.com or call (800) 851 1196.

© 2018 Herman Miller, Inc., Zeeland, Michigan

® **HermanMiller**, ●, Action Office, Aeron, Aside, Avive, Canvas Office Landscape, Caper, Celle, Co/Struc, Eames, Embody, Equa 2, Ergon 3, Ethospace, Exclave, Fine-Tune, FlexFront, Formcoat, Ground Cloth, Herman Miller Healthcare, Layout Studio, Maharam, Meridian, Mirra, Passage, Pellicle, Perspectives, PostureFit, Resolve, Sayl, Setu, Thrive, Tu, Y-Tower, and Z-Axis are among the registered trademarks of Herman Miller, Inc., and its owned subsidiaries.

™ AireWeave, Bubbletack, Cellular Suspension, Compass, Connect, DOT, Durawrap, Everywhere, Flex-Edge, Hopsak 2, Intent, Iota, Keyless Entry, Latitude, Lyris 2, Motia, Multiscrim, Nelson, Renew, Stackable, Swoop, TriFlex, Twist, and Verus are among the trademarks of Herman Miller, Inc., and its owned subsidiaries.

®Chemsurf® is a registered trademark of Wilsonart International.

Corian® is a registered trademark of E.I. du Pont de Nemours and Company Corporation.

FLEXNET™ is a trademark of Milliken & Company.

Floor Saver Glide® is a registered trademark of Carpin Manufacturing, Inc.

Geiger® is a registered trademark of Geiger International.

Microsoft® and Natural® Keyboard are registered trademarks of Microsoft Corporation.

Place Textiles® is a registered trademark of Place Textiles.